

Training Manual

Pollution Prevention Training For Pretreatment Inspectors

Prepared for:

California State Water Resources
Control Board
Division of Water Quality
P.O. Box 944213
Sacramento, CA 94244-2130



Prepared by:

Office of Water Programs
California State University
6000 J Street
Sacramento, CA 95819-6025



Pollution Prevention Training for Pretreatment Inspectors

TABLE OF CONTENTS

Introduction	Unit 1
Metal Finishing Overview	Unit 2
Material Substitution	Unit 3
Bath Life Extension	Unit 4
Reducing Drag-Out	Unit 5
Drag-Out Recovery	Unit 6
Rinse Water Reduction	Unit 7
Spent Bath Reuse	Unit 8
Rinse Water Reuse	Unit 9
Recycle Rinse Water	Unit 10
Improving WWTS Efficiency	Unit 11
Summary and Pollution Prevention Advocacy Discussion	Unit 12
Proposed MP&M Rule	Unit 13
Site Visit	Unit 14
Checklist and References	Appendix

Introduction – Welcome to this training course on pollution prevention for pretreatment inspectors. With your attendance at this training, you have already been identified as an experienced inspection professional. One of the primary responsibilities of your profession is to protect the environment by helping industries to minimize discharge of pollutants into sewer systems and ultimately into the environment. This course is designed to introduce pollution prevention concepts applicable to the metal finishing industry that will help you help industries reduce their pollutant discharges and their cost of operation. The course is also designed to take advantage of your experience and the experience of your classmates by encouraging sharing of information. The instructor will open the class by inviting everyone to introduce themselves and describe their experience. The instructor, the presentation materials, and your classmates are all resources to enhance your knowledge of pollution prevention.

1. Pollution prevention and process efficiency. Pollution prevention practices and process efficiency are closely related. Process efficiency is generally thought of in terms of optimizing production with the goal of optimizing profit. Since many pollution prevention practices minimize chemical usage, process bath and rinse downtime, water usage, and wastewater discharge volume, throughput and profits are optimized by implementation of pollution prevention practices.

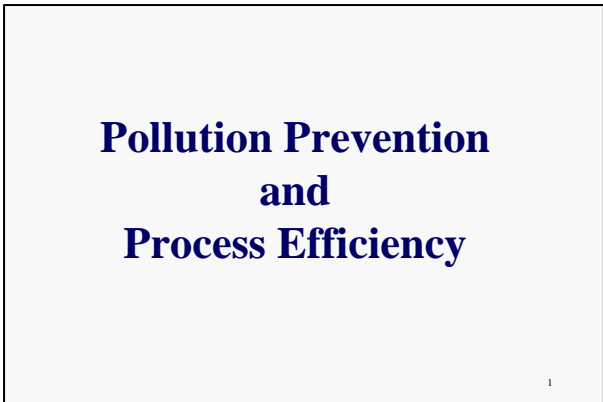

2. Workshop objectives will focus on providing the attendees a general understanding of common P2 techniques, approaches and tools. Did you come today with other objectives you would like to share?

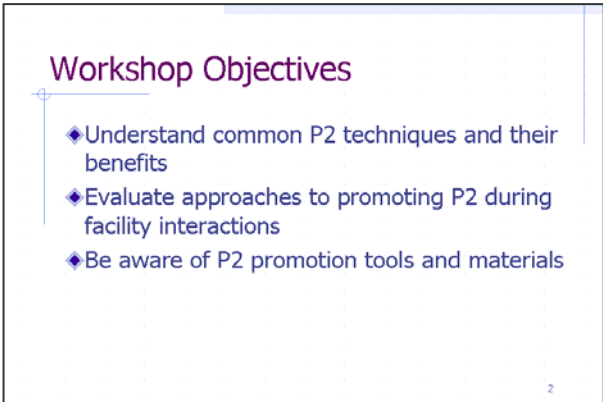

3. The workshop agenda will include lecture on both technical P2 topics and associated case studies as well as a visit to a local metal finishing facility to experience, first-hand, issues faced when performing P2 technical assistance. In addition, the workshop is designed for your participation and sharing of ideas and experiences during breakout exercises and group discussions.

Workshop Agenda

- ◆ P2 Techniques and Technologies
- ◆ Case study examples of pollution reductions and economic savings
- ◆ Group discussions on inspector roles and approaches
- ◆ Facility visit

3

4. How birds see the world. This slide illustrates differences in perspectives. Whereas many in the regulated community see environmental management as a cost burden to business, pollution prevention practices can actually improve productivity and the bottom line!

How Birds See the World



Looking at **Environmental Management** from a different perspective!!

A Tool for Competitiveness!

2

5. Production and quality considerations. This is a listing of production and quality considerations from an industry perspective. All of these considerations can be impacted in a positive way by implementing pollution prevention practices. Can you think of other considerations?

Production and Quality Considerations

- Production rate (i.e., throughput)
- Chemical balance and process bath purity
- Drying and oxidation concerns
- Rinse quality and effectiveness
- Other considerations?

3

6. Process efficiency and P2 considerations. The issues raised by this slide are once again about perspective and educating metal finishing shop owners and managers about the financial and environmental benefits of implementing pollution prevention practices.

Process Efficiency and P2 Considerations

- Does owner know the impacts of current operating conditions on material use and waste generation?
- How much are current operating practices costing the company in time, materials, disposal costs?

4

7. P2 principles for metal finishing. The listing of principles in this slide summarizes the goals of pollution prevention. Now look at the list again and think about each item from a metal finisher's perspective. Each of these listed items will save the finisher money and will ultimately improve the bottom line!

P2 Principles for Metal Finishing

- 1 Use the least toxic/easiest to manage process chemistries
- 2 Extract the most life (use) out of process chemistries
- 3 Keep process chemistry solutions where they belong: in the tanks
- 4 Return as much escaping solution (drag out) as possible to the tanks
- 5 Use the least amount of rinse water required for good rinsing

5

8. Production quality is P2. This slide illustrates the high environmental and financial cost of rejects and rework, thereby stressing the importance of quality to reduce rejected parts. Owners and managers are generally aware of the financial impact of rejects and rework but are often not aware of the environmental impact, which also affects bottom line costs.

Production Quality is P2

Rejects and rework triple the waste:

- Raw materials and waste for initial plating
- Initial plating stripped and discarded
- Raw materials and waste to replate

9. Case Study – Rejects and WWTS sludge generation. This graph illustrates the points made in the previous slide through a case study of a metal finishing shop that improved quality control to reduce the number reject parts. The graph illustrates the concomitant reduction in WWTS sludge – reducing treatment and disposal costs for the company.

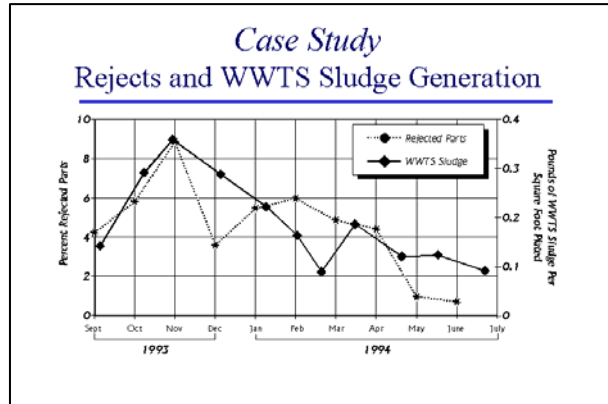

10. P2 implementation. Implementing P2 practices requires planning and effort, effort that will pay off in improved efficiencies and reduced costs. The issues that must be considered for a successful implementation are listed for discussion.

- ### P2 Implementation
- Emphasis on measurement and monitoring: production, chemical additions, process parameters
 - Input from staff: maintain measurement systems, feedback on implementability
 - Trial and error approach: extending bath life, drag-out reduction, reduced water flows
 - Understand and control processes prior to pursuing technologies
 - Continuous improvement philosophy

11. P2 case study. This slide introduces a video clip illustrating a P2 success story. The company featured was experiencing a high reject rate from their hard chrome plating process, which was costing the company in time, labor, materials, and increased waste generation. Through innovative in-house engineering efforts, they solved their problem, thereby saving money, increasing production, and reducing waste generation.

- ### P2 Case Study
- Video: Hard chrome plating reject reduction

12. P2 case study – decreased reject rates.

This graph illustrates the significant reduction in rejected parts resulting from the implementation of the external cooling unit for the hard chrome-plating tank featured in the video.

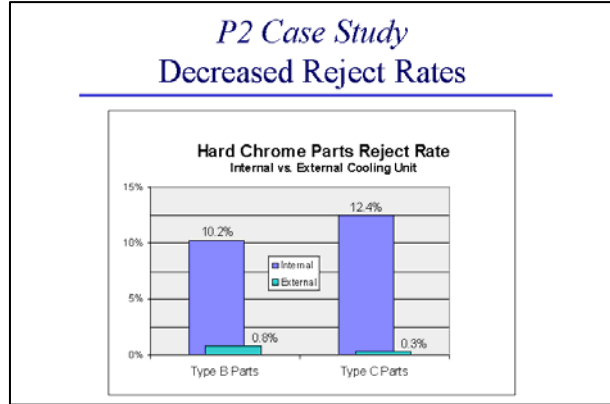

13. P2 case study – decreased reject rates.

This slides lists the measured benefits resulting from the successful implementation of the external cooling unit featured in the video. The listed benefits illustrate the relationship between P2 and bottom line. Owners and managers, if they are made aware of the economic benefits of P2

- P2 Case Study*
Decreased Reject Rates
- 10% reduction Cr^{+6}
 - 90% reduction in sludge generation
 - Reduced stripper solution (not quantified)
 - 50% increase in production capacity due to technology change and reject reduction

implementation, will enthusiastically embrace the concept. You, the inspector who is educated in the benefits of P2 practices, can be the catalyst in the implementation of pollution prevention practices by the plating industries operating in your area.

Metal Finishing Overview - These days everyone doing pollution prevention assistance is interested in helping out the metal finishing industry; ever wonder why? Metal finishing, when taken as a whole, is one of the largest users of toxic chemicals in the country. Electroplating alone is the second largest end user of cadmium and cadmium compounds. Electroplating also accounts for a substantial amount of chromium use in the United States. In other words, this industry is responsible for managing large amounts of hazardous materials (Davis, 1994). Many industries use metal finishing in their manufacturing processes including automotive, electronics, aerospace, medical equipment, computers, hardware, jewelry, heavy equipment, appliances, tires, and telecommunications. Metal finishing makes items more usable and more durable, conserving resources by extending the useful life of plated items. Take a look around the room and try to identify plated items.

1. Metal finishing overview. A brief overview of the metal finishing industry, the reasons for metal finishing, and the pollution resulting from metal finishing processes will be presented in this section. Traditional approaches to treating pollution will be discussed and the pollution prevention approach to reducing pollutants will be introduced.

Metal Finishing Overview

Pollution Prevention Opportunities

2. Why metal finishing? There are many reasons for metal finishing. Without metal finishing, products made from metal would only last a fraction of their present lifespan due to corrosion and wear. Finishing is also used to enhance electrical properties, to form and shape components, and to enhance bonding of adhesives and/or organic coatings.

Why Metal Finishing?

Metal finishing alters the metal surface to enhance :

•Corrosion resistance	•Hardness
•Wear resistance	•Solderability
•Appearance	•Tarnish resistance
•Electrical conductivity	•Chemical resistance
•Electrical resistance	•Ability to bond to rubber (vulcanizing)

3. Metal finishing. This photograph illustrates the change in appearance of a metal tie-down anchor resulting from metal finishing. The finishing process also improved the wear and corrosion resistance of the component.

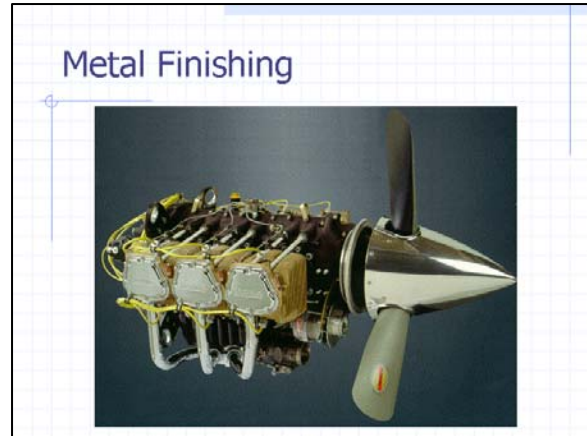

4. Typical plating processes. A major percentage of metal plating is done using electrolytic plating. In electrolytic plating, the parts are immersed in a metal salt solution and an electrical current is passed through the solution, with the parts functioning as the cathode in the DC circuit. Metal ions in solution are reduced to elemental metal at the cathode surface and plate onto the part. Electroless plating also involves immersing parts in a metal salt solution. Metal ion reduction is accomplished chemically, however, rather than with an electrical current. Chemical

Typical Plating Processes

- Electrolytic Plating
 - Ag, Al, Au, Cd, Cr, Fe, Pb, Sn, Zn brass, bronze
- Electroless Plating
 - Copper and nickel
- Chemical and Electrochemical conversion processes
 - Phosphating, anodizing, chromating, coloring, passivating

reducing agents, complexing agents, and buffers are used to control and complete the reaction. Conversion processes include phosphating to prepare the metal surface for further treatment, anodizing to form a non-porous, oxidized protective layer on the metal surface, chromating (using hexavalent chromium) to deposit a protective film on metal surfaces, passivating (using nitric acid and dichromate) to prevent corrosion, and metal coloring using chemical dyes for appearance.

5. Typical support processes. Support processes are generally for surface preparation to enable good surface bonding of the plating metal to the part. Supporting processes use many solvents and chemicals of concern, including acids, bases, organic solvents, surfactants, and abrasive compounds.

Typical Supporting Processes

- Degreasing
- Cleaning
- Pickling
- Etching
- Polishing

6. Sources of pollution. Acid, bases, organic solvents, surfactants, and abrasive polishing compounds are used for metal preparation and become part of the waste stream from metal finishing operations. Metal salts, phosphating agents, reducing agents, cyanide, chemical buffers and complexing agents are all used in metal plating processes and also become part of the waste stream.

Sources of Pollution

- Metal Preparation:
 - Cleaning solvents
 - Surfactants
 - Acids and Bases
- Metal finishing
 - Metal salt solutions

7. Metal finishing shops fall into two basic types: captive and job shops that significantly affect the P2 options that are available to a company. Job shops, because of the variety of parts they process, require P2 solutions that accommodate flexibility; whereas, captive shops tend to allow for more automation and control.

Captive and Job Shop

Captive

- ◆ Dedicated to one or several workpiece types and or clients
- ◆ Continuous processing, standard process flows and control
- ◆ Amendable to high level of automation

Job Shop

- ◆ Large number of workpiece types and clients
- ◆ Smaller orders, varied parts, customized processes
- ◆ Reliance on manual operations, less opportunity for automation

8. Metal finishing processes can be categorized as hand or automated and similar to a captive shop, the more automated a process line, the higher the opportunity for tight control.

Manual and Automated

Manual

- ◆ Process steps performed by hand
- ◆ Smaller size workpieces, lower production

Automated

- ◆ Fully automated; only requires manual racking and unranking
- ◆ Associated with high production quantities and rates
- ◆ Semi automated; requires manual control of hoists and rails
- ◆ Associated with larger workpieces, lower production rates, and varied parts

9. Parts can be finished either individually on “racks” where each part is racked separately, or loaded together with other parts and tumbled within a barrel for the finishing process. Typically, parts that are smaller and relatively simple in shape are processed in barrels. Barrel lines will typically generate a lot more drag-out than a rack line and subsequently require more water to adequately rinse parts.

Barrel and Rack

Barrel

- ◆ Parts processed in containment “barrel”
- ◆ Typically small workpieces with low level of plating or processing tolerance requirements
- ◆ Typically use cyanide/metal plating solutions and higher bath concentrations
- ◆ Drag-out rates and water use relatively high

Rack

- ◆ Workpieces hung or mounted to frames (racks)
- ◆ Most common and versatile processing method
- ◆ Drag-out rates and rinsewater use easier to control

10. Historical approach to pollution. The historical response to pollution has been an end of pipe approach, where pollution loads were considered a byproduct of production that had to be treated prior to discharge to the sanitary sewer. As pollutant loads increased, capacity increases in treatment works were added and treatment efforts and cost increased accordingly. As sludge production increased, higher expenses were incurred for separation, dewatering, transport and disposal. End of pipe treatment expenses were considered an unavoidable cost of doing business.

Historical Approach to Pollution

End of pipe approach:

- Treat wastewater to reduce pollutant concentrations prior to discharge.
- Dispose of residual solids to hazardous waste disposal facility
- Pay the price!

11. Pollution prevention approach. The P2 approach considers pollution as avoidable by changes in operating practices, process configurations, technologies, and chemical selections. This is not to imply that all pollutants can be eliminated (zero discharge), but that many pollutant loads can be significantly reduced with the resultant cost savings providing a benefit to the metal finishing shop’s bottom line.

Pollution Prevention Approach

- Reduce the amount of pollutants generated
- Reduce the volume of contaminated water generated
- Save money in the process!

12. Hierarchy of P2 and waste management for metal finishing. This hierarchy will serve as a guideline for the remainder of our class. It is arranged in order of strategy or approach, from top to bottom, that will provide the greatest return on investment for its implementation. Major categories illustrated are source reduction, followed by recycling, and finally improved treatment. Historically, industry has concentrated most efforts on the last major category, improved treatment, which is the least cost effective approach of all listed. Within each major category, individual practices are listed; again in order of greatest to least “return.”



Material Substitution – Often the most effective method of pollution prevention is substitution of a toxic material used in a process with one that is either less toxic or non-toxic. Many opportunities for material substitution exist in the metal finishing industry. Some examples are substituting titanium parts racks for aluminum racks (anodizing), substituting stainless steel racking hooks and wires for copper (passivation), and substituting washable filter elements for disposable ones. Pollution prevention by substitution of chlorinated solvents, traditionally used for cleaning and preparation, will be presented in detail.

Chlorinated solvents have traditionally been used for degreasing because (1) they quickly dissolve organic soils such as oil, grease, and dirt from parts and (2) residual solvent on parts evaporates rapidly, leaving them clean, dry, and ready to be finished. Today, however, use of most chlorinated solvents is being phased out by increasingly stringent state and federal air regulations. Some solvents used in metal finishing, such as 1,1,1-trichloroethane (TCA), are ozone-depleting and global warming compounds. Other solvents, such as perchloroethylene (PERC) and trichloroethylene (TCE), are subject to increasingly stringent regulations because of the risks they pose to human health.

Numerous aqueous, or water-based, cleaning chemicals are now available that are significantly less toxic than chlorinated solvents. Because organic soils are less soluble in water than in chlorinated solvents, chemical and physical mechanisms such as surfactants, emulsifiers, agitation, sprays, and ultrasonics are often used to enhance cleaning effectiveness. This unit focuses on ultrasonic aqueous cleaning as an alternative to solvent degreasing.

1. Material substitution. In this unit, pollution prevention by material substitution will be presented. By replacing a toxic substance in the metal finishing process with one that poses a much smaller environmental and human health risk and reducing operational cost, the goals of implementing economically attractive pollution prevention practices are attained.

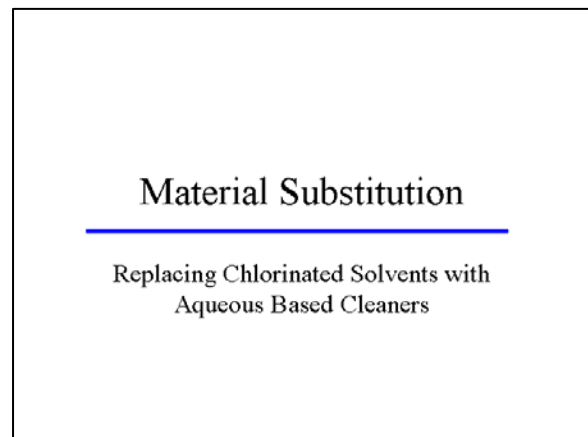

2. Hierarchy of P2 and waste management strategies for metal finishing. The first item listed in source reduction, material substitution, will be presented in this unit. The hierarchy lists strategies in the general order that will provide the most effective impact on pollution reduction through their implementation.

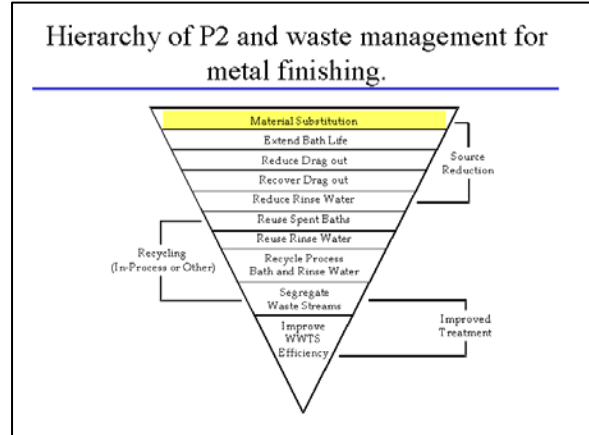

3. The need for cleaning. Metal finishers plate parts made by a variety of manufacturing processes and by a variety of manufacturers. Each part must be free of surface contaminants prior finishing. Failure to remove all contamination can result in incomplete or poor-quality plating and contamination of the process baths, which can degrade the quality of plating on all parts.

The Need for Cleaning

- Parts surfaces are contaminated with oils, greases, and soils from the manufacturing process.
- Contaminants interfere with the plating process – causing rejected work.
- Contaminants foul process baths

4. Chlorinated solvents. Chlorinated solvents have traditionally had high usage rates for cleaning parts prior to metal finishing due to their desirable properties of effective cleaning and rapid evaporation from part surfaces. Unfortunately, this class of solvents poses environmental and human health risks, which necessitate costly handling and disposal procedures. Therefore, replacing chlorinated solvent cleaning with a less toxic alternative has both environmental and economic benefits.

Chlorinated Solvents

- Clean parts effectively
- Evaporate rapidly
- Are suspected ozone-depleting compounds
- Pose human health risks
- Are increasing subject to regulatory elimination from use

5. Aqueous-based cleaning solutions. Aqueous-based cleaning solutions have been developed that can effectively clean parts, leaving the surface residue-free and ready for plating. Other benefits of aqueous-based cleaning solutions over chlorinated solvents are their longer useful life, their non-hazardous formulations, and their treatability in on-site wastewater treatment facilities.

Aqueous-Based Cleaning Solutions

- Can effectively clean parts in preparation for finishing
- Have a longer useful life than solvents
- Are generally non-hazardous
- Are typically treated with on-site wastewater treatment equipment.

6. Reasons for replacing solvent degreasing with aqueous cleaning. Reasons are many, ranging from regulatory compliance to safety, improved work conditions, eliminating hazardous waste, and reducing cost. It is the last one, saving money, that will have the greatest influence in instituting a change in cleaning practices.

Reasons for Replacing Solvent Degreasing with Aqueous Cleaning

- Comply with federal and state regulations
- Eliminate solvent storage and handling
- Eliminate potential for accidental releases
- Create safer working conditions
- Eliminate air regulation compliance costs
- Eliminate solvent purchase and disposal costs
- Eliminate emissions of ozone-depleting, global warming, and hazardous compounds
- SAVE MONEY!

7. Extended life of aqueous cleaning solutions. Unlike with solvents, most organic soils are immiscible in aqueous cleaning solutions. Therefore, aqueous solutions can have contaminants separated and removed relatively easily – often while the solution remains in service. On line oil separators or less sophisticated absorbents can be used to remove oils from solution. Heavy soils settle out and can be filtered to remove them from solution, extending the useful life of aqueous cleaning solutions. In contrast, solvents become saturated with contaminants and must be replaced with much higher frequency.

Extended Life of Aqueous Cleaning Solutions

- Most organic soils are immiscible in aqueous cleaning solutions.
- Oils can be removed from the surface and heavy soils can be filtered from the bottom.
- Biodegrading filters can be used to remove organic contaminants.

8. Types of aqueous cleaning units. Several types of cleaning processes exist that are compatible with aqueous-based cleaning solutions. All utilize some method of agitation to enhance cleaning and reduce cleaning time.

Types of Aqueous Cleaning Units

- Spray – high pressure spray in an enclosure
- Immersion – agitation with mechanical oscillation, nozzles, or ultrasonics
- Wet blast – high pressure water and abrasive slurry
- Sink-top – manual scrubbing.

9. Case study – ultrasonic cleaning. A Southern California metal finisher decided to investigate replacing its PERC parts cleaning process with an aqueous-based cleaning process. The solvent process created an expensive air permitting requirement, health risks for employees, and significant labor expenses. The shop had both rack and barrel plating lines and all parts required cleaning prior to plating.

Case Study – Ultrasonic Cleaning

- Plating operations include Cu, Ni, and Cr electroplating – rack and barrel lines.
- Parts are cleaned of oil, particulates, and buffing compounds using a solvent-vapor spray degreasing unit.
- PERC usage = 6,100 lb/year.

10. Aqueous-based cleaning trial. After investigating several processes, ultrasonic cleaning was selected because it was thought to have the greatest potential to clean the oils, greases, and abrasive buffing compounds commonly found on the parts delivered from manufacturers. The abrasive buffing compounds presented the most difficult cleaning challenge for the company and they were eager to see if the aqueous cleaning solution could remove the contaminant.

Aqueous-Based Cleaning Trial

- Ultrasonic cleaning unit (1,200-watt, 40-kilohertz transducers) holding 100 gallons of cleaning solution.
- Electric heater maintains solution temperature at 170°F.
- Daraclean 236 cleaning solution
- Hydrophobic absorbent pads to remove oil

11. Results. The aqueous-based cleaning solution used in conjunction with the ultrasonic cleaner effectively removed all contaminants from part surfaces. Cleaning was accomplished in half the time it took to clean parts with chlorinated solvent. Workers reacted positively to the elimination of unpleasant, harmful fumes. Another benefit realized was the treatability of the spent aqueous-based cleaning solution in the on-site wastewater treatment facilities. Spent solvents had to be transported off-site for treatment, recycling, and hazardous waste disposal, all at significant expense.

Results

- All parts were cleaned effectively
- Time for cleaning was reduced 50%
- Labor for cleaning was reduced 50%
- Workers reacted positively to the elimination of unpleasant, harmful fumes
- Spent cleaning solution could be treated on-site

12. Ultrasonic aqueous cleaning results. Labor and expenses were reduced by switching to the ultrasonic aqueous cleaning process. Payback for system installation was 1.7 years based on capital cost and annual operation and maintenance (O & M) savings.

Ultrasonic Aqueous Cleaning Results

	Per Year		Annual Savings
	PERC	Aqueous	
Chemical Purchase Cost	\$2,890	\$2,400	\$490
Haz Waste Disposal Cost	\$306	\$60 (oil pads)	\$250
Cleaning Labor	1,320 hours	660 hours	\$4,620
O & M Labor	52 hours	26 hours	\$1,320
Air Permitting Cost	\$1,780	\$0	\$1,780
Total Annual Savings = \$8,440			
Capital Cost - \$14,000 (assuming unit purchase)			
Payback Period = 1.7 years			

Bath Life Extension – One of the primary pollution prevention objectives is to reduce the frequency of chemical bath and rinse tank disposals. The most effective method to reduce the disposal frequency is to institute practices to extend the useful life of the baths. The result of bath life extension practices is reduced wastewater generation and reduced costs due to avoided new bath make-ups, wastewater treatment, and solids disposal. Several strategies for extending the useful life of process baths will be presented in this section.

1. Bath life extension. Methods to extend the useful life of process bath solutions will be presented. Methods will include maintenance scheduling based on monitoring, chemical enhancer use, bath filtration, drag-in reduction, and use of deionized water for bath make-up.

Bath Life Extension

Process Bath Monitoring and Maintenance

1

2. Hierarchy of P2 and waste management for metal finishing. Bath life extension is the next source reduction technique in our hierarchy of pollution prevention and waste management strategies.

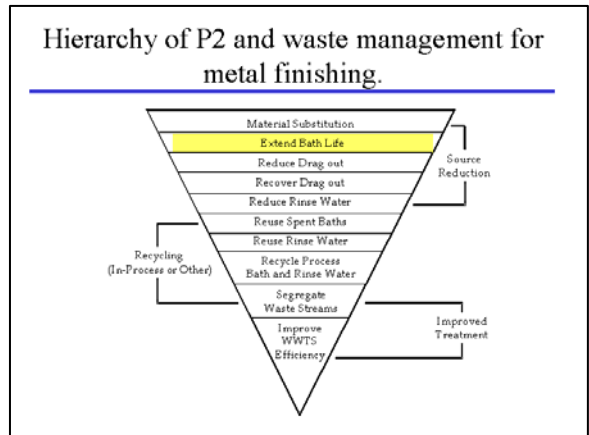

3. Bath degradation. Bath degradation occurs over time and results from a variety of factors. Depletion of bath chemicals results from plating and from drag-out as parts are removed from the bath. Imbalance of bath chemistry results from selective depletion of certain components from the bath as plating depletes metal ions from solution. Buildup of contaminants results from drag-in when parts are not adequately rinsed of upstream process fluid contents prior to immersion in subsequent process baths.

Bath Degradation

- Depletion of bath chemicals (drag-out)
- Imbalance of bath chemistry
- Buildup of contaminants (drag-in)

2

4. Spent bath costs. Costs incurred when a spent bath must be dumped include new process chemicals to make up the replacement bath, chemicals used in waste treatment of the dumped bath, O & M costs for waste treatment and disposal, and sludge processing, transportation, and disposal. These costs create a significant operating expense for metal treatment facilities and reducing them provides both economic and environmental benefits for the metal finishing business.

Spent Bath Costs

- Process chemical use
- Treatment chemical use
- Waste handling and treatment operation labor
- Sludge (or other residual) disposal

3

5. Bath treatment and disposal. Bath treatment and disposal can be accomplished by batch treatment on-site, by bleeding spent bath contents into an on-site wastewater treatment process, or by containerizing and shipping off-site for treatment and disposal. All options cost money. Options 1 and 2 create sludge, which must be processed and transported and disposed as hazardous waste. Option 3 eliminates on-site treatment but is expensive.

Bath Treatment and Disposal

1. Batch treated on site
2. Bleed into an on-site WWTS
3. Containerize and ship off site

- *Options 1 and 2 create sludge!*
- *Option 3 is expensive!*

4

6. Bath life extension techniques. Several proven strategies are available to extend bath life. Methods include scheduling bath changes based on production or on bath conditions, rather than simply on a time schedule. Reducing drag-in contamination, improving bath purity, maintaining bath chemistry, using enhancer additives, and reducing drag-out all are proven bath life extension methods.

Bath Life Extension Techniques

- Schedule bath changes based on production or bath conditions
- Reduce drag-in contamination
- Improve bath purity
- Maintain bath within control parameters
- Use a bath additive, or “enhancer”
- Reduce drag out

5

7. Case Study: Bath Life Extension. A two-phase case study will be presented in which a metal finishing shop implemented multiple bath life extension practices to reduce the number of dumps of their nickel acetate seal bath.

Case Study: Bath Life Extension

Facility Description

- Processes aluminum parts for aerospace and industrial customers
- Performs sulfuric acid anodizing and chromate conversion (chem-film)
- Uses a manually-operated hoist
- 23 employees, two shifts per day

6

8. Nickel acetate seal bath. The shop operated a single nickel acetate seal bath following a dye operation. The seal bath was the final process on the anodizing line. It was dumped when smut formed on parts, averaging about 2.3 times per month.

Nickel Acetate Seal Bath

- Operate single, 560-gallon nickel acetate seal
- Follows dye operation (primarily black dye)
- Final process on anodizing line
- Bath dumped when smut forms on parts
- Historically dumped 2.3 times per month on average

7

9. Nickel acetate bath monthly cost. Costs components are listed and summed to illustrate the total month cost to operate the seal bath.

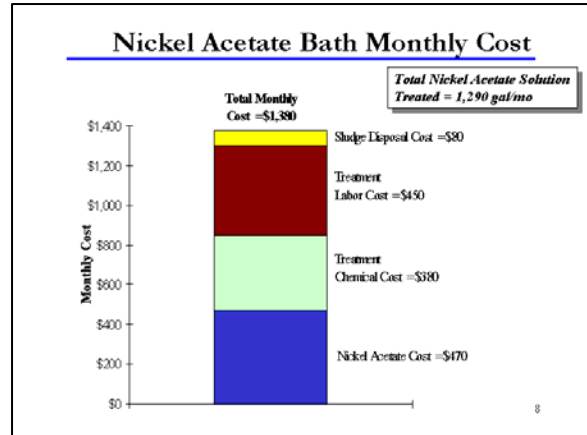

10. P2 assessment findings. Independent assessment of the bath dump frequency identified inadequate process monitoring and control and drag-in as the primary causes for bath dumps. A strategy was developed to maintain bath control, decrease contamination, and to use a bath additive to reduce smut formation.

P2 Assessment Findings

- Causes of bath dumps
 - Inadequate process monitoring and control
 - Drag in from preceding process operations
- Strategy
 - Maintain process bath control
 - Decrease bath contamination
 - Use a bath additive

11. Implementation plan. A strategy was developed to implement P2 practices in two phases after gaining an understanding of baseline conditions. Phase 1 consisted of implementing process bath control and using a bath additive. Phase 2 consisted of adding a filtration system, using DI water for bath make-up, and installing a spray rinse system to remove black dye from parts before immersing them in the nickel acetate seal tank.

Implementation Plan

- Understand baseline conditions
- Phase I: Process bath control and bath additive use
- Phase II: Filtration system, DI water, and black dye spray system

12. Nickel acetate seal process bath control. The table lists the parameters monitored, the target range, measurement frequency, and the method of measurement.

Nickel Acetate Seal Process Bath Control			
<u>Parameter</u>	<u>Target Range</u>	<u>Measurement Frequency</u>	<u>Measurement Method</u>
Temperature	155 to 165 °F	Daily	Meter
pH	5.8 to 6.0	Daily	Meter
Concentration	1.5 to 2.5%	Every 2 Days	Titration

11

13. Use of bath additive. A proprietary bath enhancer consisting of several chemical agents was selected to enhance bath performance. The agent contained wetting and dispersing agents to improve the seal quality, prevent smut formation, and minimize water spotting.

Use of Bath Additive	
<ul style="list-style-type: none"> • Introduce chemical agents to boost bath performance • Novaseal Enhancer <ul style="list-style-type: none"> – Contains wetting and dispersing agents – Improve seal quality – Prevents smut formation – Minimizes water spotting 	12

14. Bath additive costs. The slide lists the chemical and labor costs associated with use of the bath additive.

Bath Additive Costs	
<ul style="list-style-type: none"> • Added an average of 1.3 gallons of enhancer per week • Enhancer unit cost = \$23/gal • Overall costs <ul style="list-style-type: none"> – Enhancer = \$30/week – Labor = \$25/week 	13

15. Nickel acetate bath dump frequency and volume. This graph illustrates the reduction in bath dump frequency and volume that resulted from implementation of phase 1 implementation.

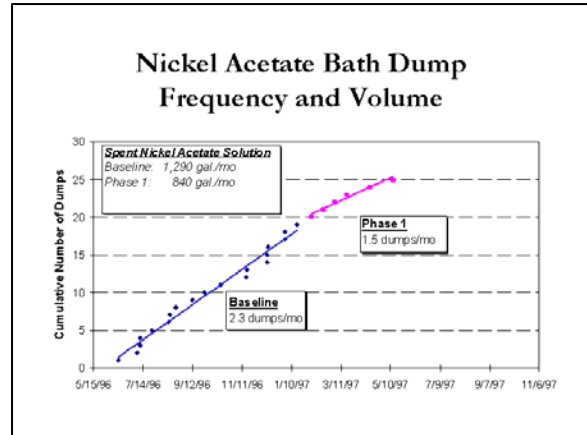

16. Phase II: decrease bath contamination. After assessing the reduction in bath dump frequency resulting from the phase 1 improvements, phase 2 changes were implemented. They consisted of installation of a continuously operating filtration system to remove solid contaminants, using DI water for new bath make-ups to reduce unwanted free ion concentrations in new baths, and installation of a spray rinsing system to rinse dye from parts before immersing them in the seal tank.

Phase II:
Decrease Bath Contamination

- Install continuous bath filtration system
- Use DI water for new bath make-ups
- Add a spray rinse to preceding black dye operations

15

17. Layout. This schematic illustrates the addition of the spray rinse and filtration systems for phase 2 implementation.

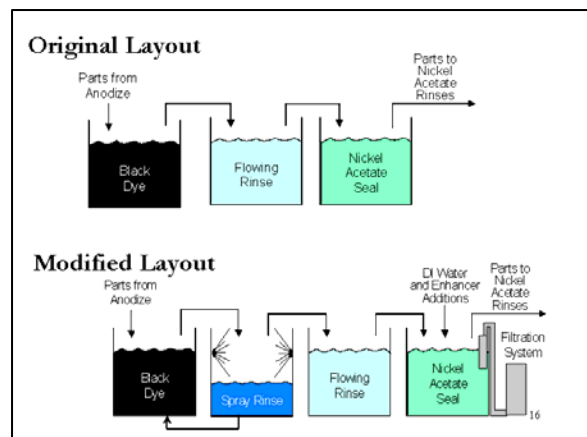

18. Continuous filtration system. The filtration system removes suspended solids from the bath solution by capturing them in one of six, 20-micron cartridge filters, which were replaced weekly. It also helped maintain uniform bath temperature by constantly recirculating bath fluid.

Continuous Filtration System

- Removes suspended solids
- Maintains uniform bath temperature and concentration (by mixing)
- Design features
 - Holds six cartridge filters
 - 20 micron filters, replaced once a week
 - Centrifugal pump
 - Pressure-sensitive, automatic shutoff switch

17

19. Nickel acetate bath filtration system. The photograph illustrates the filtration system and controls.

Nickel Acetate Bath Filtration System



18

20. Filtration system costs. The table lists all of the costs, capital and O & M, for the filtration system. Documenting costs and savings are critical for convincing businesses to undertake changes.

Filtration System Costs

<u>Capital Costs</u>		<u>O&M Costs</u>
Housing	\$1,100	Labor = \$25/week
Filters (6)	\$59	Filters = \$59/week
Pump	\$870	
Pressure switch	\$115	
Motor starter	\$101	
Hose and fittings	\$258	
<u>Installation labor</u>	<u>\$300</u>	
Total capital	\$2,803	

19

21. DI water for bath make-ups. Use of DI water reduced the formation of complexes, which reduce chemical availability and necessitate using higher metal salt chemical concentrations. The usage rate and cost of DI water are listed.

DI Water for Bath Make-ups

- Originally used city water for bath make-ups
- DI water minimizes the introduction/formation of chemical complexes and compounds
- Purchased from Pure Rain Technologies
- 420 gallons of DI water used for each new bath
- Also use DI as makeup for evaporative losses
- System and installation = \$403

20

22. Spray rinse system. The design features and benefits of the spray rinse system are listed.

Spray Rinse System

- **Design features**
 - Recessed nozzles
 - Check valves to maintain water pressure
 - Activated by a foot pedal
- **Benefits**
 - Reduced black dye drag-in into nickel acetate seal
 - Black dye recovery and reuse in bath
 - Reduced flow rate on spray rinse

21

23. Spray systems costs. The capital and O & M costs for the spray system are listed and totaled. These cost will be combined with the costs from the other components of the project and compared to cost savings.

Spray System Costs

<u>Capital Costs</u>		<u>O&M Costs</u>
Tank liner*	\$911	Labor = \$50/week
Nozzles (30)	\$225	
Check valves (6)	\$17	
Piping	\$112	
Pressure reducer	\$46	
Foot valve	\$133	
<u>Installation labor</u>	<u>\$1,200</u>	
Total	\$2,644	

* = Tank liner was used to reinforce an old plastic tank and is not representative of typical spray system costs

22

24. Nickel acetate bath dump frequency and volume. This graph illustrates the further reduction in bath dump frequency and volume realized by the implementation of phase 2 pollution prevention practices. The combined implementation reduced bath dump frequency approximately 75%!

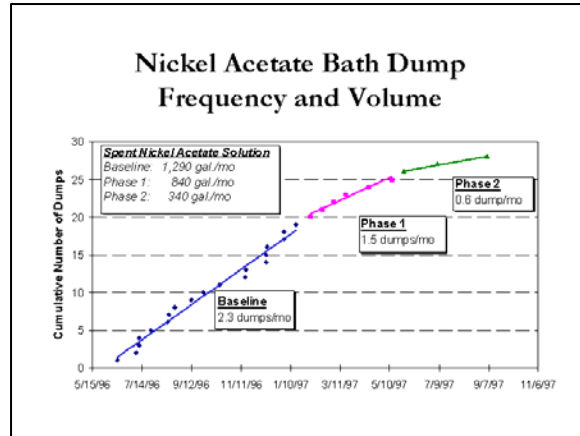

25. Bath life extension results. The table lists the savings realized by the implementation of P2 practices on the nickel acetate seal bath. The total annual savings will result in a payback period of 1.5 years for the investment in pollution prevention. The savings will continue long after the capital expenditures are recovered and waste discharge reductions will continue also.

Bath Life Extension Results

	Per Month		Annual Savings
	Before	After	
Nickel Acetate Chemicals	26 gal	6.8 gal	\$4,140
Treatment Chemicals	\$380	\$100	\$3,360
Treatment Labor	9 hours	2.4 hours	\$3,960
Sludge Generated	150 lb	39 lb	\$670
Annual Savings = \$12,130/yr*			
Capital Cost = \$5,850			
Annual O&M Cost = \$9,828			
Payback Period = 1.5 yr			

* Spray rinse savings for black dye recovery not included, typically 30% to 50 %.

26. Bath life extension results. The benefits realized from this pollution prevention project are listed. Included are a significant reduction in nickel released to the environment, cost savings of over \$12,000 per year, potential cost savings (no measurement was taken) of up to \$150 per month for black dye recovery from the spray rinse system. All in all, a very successful project!

- Bath Life Extension Results**
- 74 percent decrease in spent nickel acetate solution generation
 - Decrease of 56 pounds per year of nickel released to the environment
 - Net cost savings of \$12,130 per year
 - May realize additional cost savings through black dye recovery (up to \$150 per month)

Reduce drag-out – Reducing drag-out, the process fluid adhering to parts and racks after they are hoisted from a process tank, is a major component of any pollution prevention program. One of the major axioms of pollution prevention is to keep process fluids where they belong, in the tank. The material presented in this section will explain the mechanisms responsible for drag-out and methods to minimize drag-out and its impacts.

1. Process fluid preservation – controlling drag-out. Drag-out is responsible for loss of bath chemicals. Control of drag-out is critical in preserving process fluid and the investment the metal finisher has made in those chemicals.

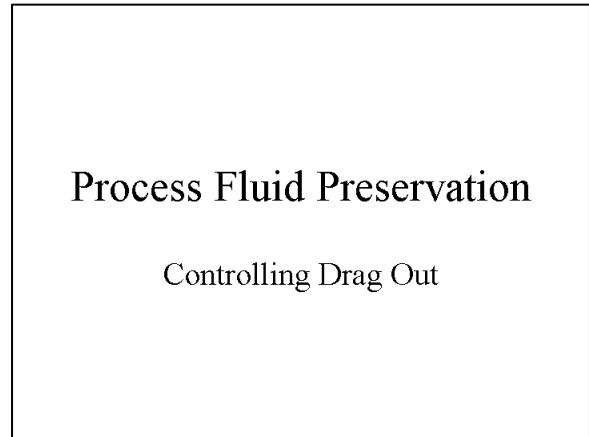

2. Hierarchy of P2 and waste management strategies for metal finishing. Drag-out recovery is one of the more cost effective pollution prevention strategies to implement and the one that will have the greatest immediate impact on reducing costs, chemical losses, and pollutant generation.

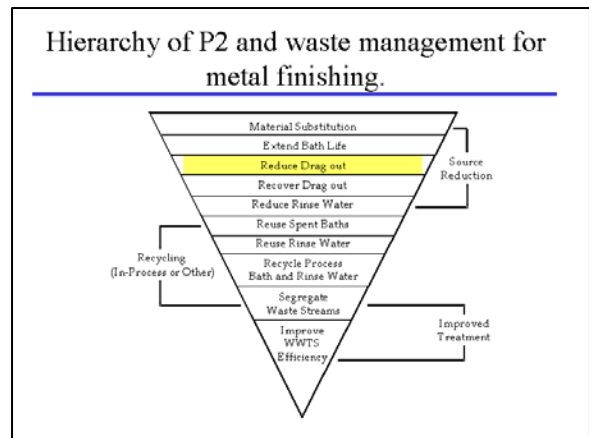

3. Drag-out. Drag out is process fluid, unintentionally removed from process tanks when it adheres to part and rack surfaces. It is lost to the process and, if not removed prior to immersion in the next bath, becomes a contaminant in that next bath.

Drag-out

- Drag-out is process fluid that adheres to parts and is unintentionally removed from process tanks
 - Drag-out is lost from the process
 - Drag-out becomes a contaminant to the next tank (drag-in)

4. Drag-out impacts. Drag-out has multiple, costly economic and environmental impacts.

Drag Out Impacts

- Increased plating chemical use
- Increased rinse water use or decreased rinse quality
- Increased drag in into next bath
- Decreased product quality

3

5. Drag-out impacts (continued).

Drag out Impacts (continued)

- Increased wastewater generation
- Increased WWTS treatment chemicals use
- Increased WWTS filter cake generation
- Increased metal concentration in the WWTS discharge

4

6. Drag-out reduction: worker practices/operations. Worker practices are the greatest contributing factor to drag-out and its reduction. It begins with racking practices and carries through to withdrawal rate and drain time

Drag Out Reduction:
Worker Practices/Operations

- Withdrawal rate
- Drainage time (↑ by 5 seconds will ↓ drag out by 30%)
- Racking
 - Work piece overlap and angle

5

7. Drag-out reduction: bath conditions. Concentration of bath chemicals is very important in controlling drag-out. Having too high a concentration increases chemical losses from drag-out. If the concentration is too low, quality suffers and rejects result. Drag-out can be reduced by using additives to reduce surface tension, thereby reducing the volume of process fluid that adheres to parts and racks.

Drag Out Reduction:
Bath Conditions

- Operating concentration
 - High concentrations increase drag out losses
 - Low concentrations can increase reject rates
- Surface tension
 - Surface tension reduction reduces drag out losses

6

8. Drag-out reduction: process configuration. Drag-out losses can be reduced significantly with proper tank and by use of drain boards to deflect drag-out that drains off of parts and racks back into the bath. Parts that have to be moved across several tanks or across floor areas to the next tank lose drag-out during transport as fluid drains from the parts and racks onto the floor or into other tanks where it acts as a contaminant.

Drag Out Reduction:
Process Configuration

- Tank proximity and layout
- Drain Boards

9. Drag-out reduction: rack and barrel.
Racking is a critical component for minimizing drag-out. Orienting parts to allow maximum drainage and minimum retention of bath fluids minimizes drag-out. Racks should be designed to enable workers to rack parts to minimize fluid retention. Often, parts can be modified to enhance drainage. For barrel plating operations, rotation of the barrel after it has been hoisted out of the bath helps return potential drag-out to the bath.

Drag Out Reduction: Rack and Barrel

- Rack design
- Work piece modification
- Barrel rotation

8

10. Impacts of withdrawal rate on drag-out.
Surface tension of bath fluid can be exploited to minimize drag-out. When parts are withdrawn slowly, surface tension helps pull fluid off of the parts and racks, leaving a thin film on the withdrawn materials. Rapid withdrawal, on the other hand, breaks the surface tension between the fluid on the part surface and the fluid in the bath. Surface tension of the fluid on the withdrawn parts then acts to retain a thicker fluid film on the parts, increasing drag-out.

Impacts of Withdrawal Rate on Drag Out

*Other conditions that impact thickness of solution are temperature and bath concentration.

9

11. Effects of parts racking on drag-out.
These photographs of the same parts, racked in different orientations, illustrate the potential for racking orientation to impact the amount of drag-out. The fins racked in a horizontal orientation will retain much more drag-out than those racked in a vertical orientation. The third photograph shows use of air to remove excess drag-out.

Effects of Parts Racking on Drag Out

Horizontal Vertical Removing Drag out

Proper racking reduced drag out by 90% for these parts!!!

10

12. Even for parts with very simple shapes, parts orientation, or the way the parts are racked relative to the rack can make a significant difference in drag-out. For example, many parts can be racked to create “drip points” that aid in drop formation and therefore reduce drag-out.



13. This graph illustrates the 15% reduction in drag-out achieved by changing the racking orientation of small square part shown in the previous slide. The change in racking orientation created a drip point, allow drag-out fluid to more easily flow from the part.

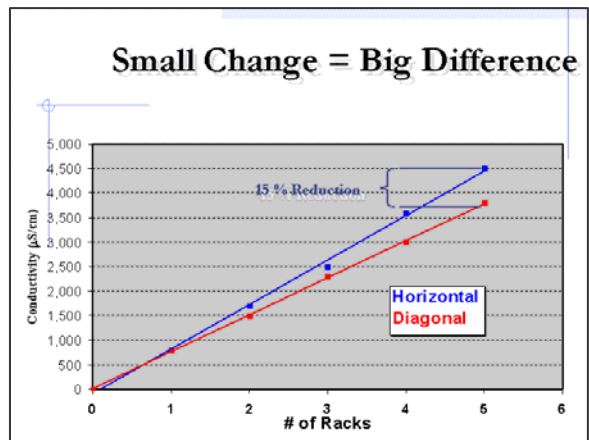

14. Often simple equipment and techniques can be used to minimize dragout that also improve quality, ergonomics, and even throughput; examples shown below include “drain pads” for use with hand racks and “dragout stairsteps” to drain cupped surfaces on a hoist line.

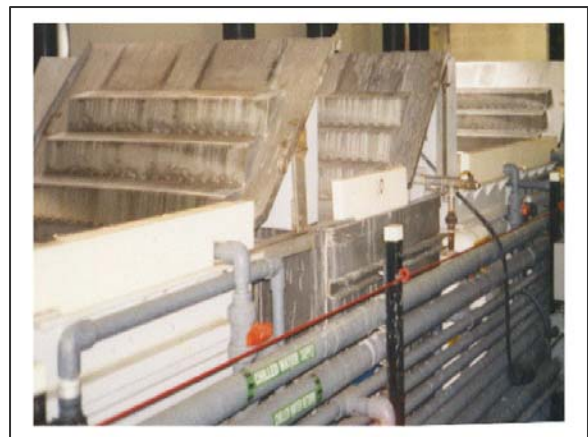
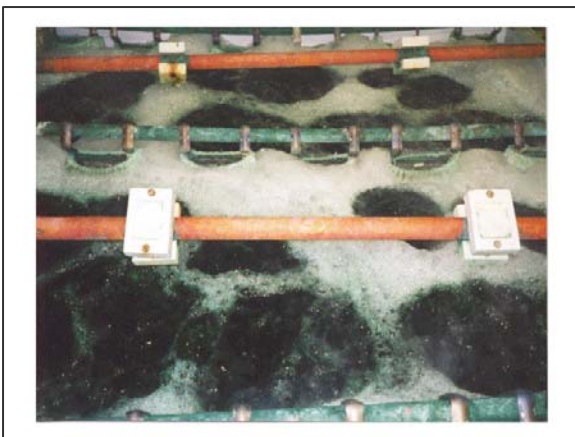

15. Drag-out impact of barrel rotation. This graph illustrates the reduction in drag-out resulting from rotation of a parts barrel after withdrawal from the process bath. A simple process that takes little time results in a 16% reduction in drag-out losses!

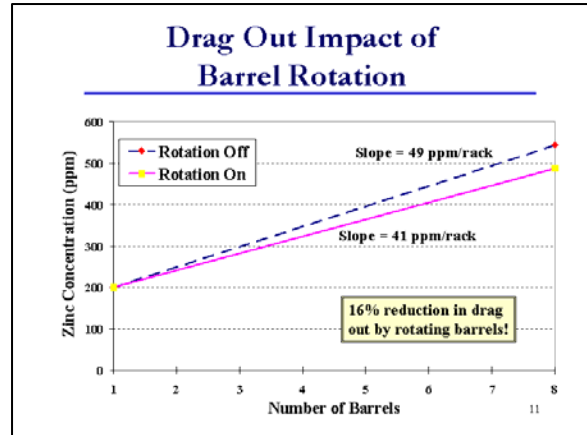

16. Average drag-out reduction. This bar graph illustrates the drag-out reductions measured when implementing selected drag-out reduction practices. Practices implemented included tilting and draining racks over the process bath after withdrawal, spray rinsing, increasing drain time, and utilizing strategic parts racking techniques. All of these techniques resulted in significant drag-out reduction and can be accomplished through employee training, without other expenditures.

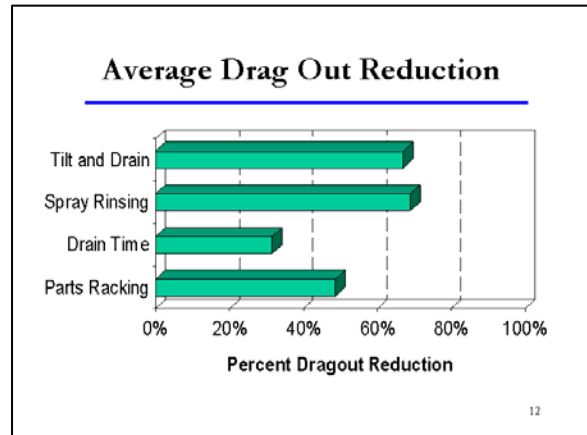

17. Because drag-out quantities are hard to “eyeball,” drag-out should be quantified to determine the effect of parts racking on drag-out. One method for measuring dragout is to monitor the buildup of dragout in a stagnant rinse tank following a process bath. The rate at which the process solution accumulates in the rinse bath is proportional to the dragout rate and can be quantified by calculating the slope of the line.

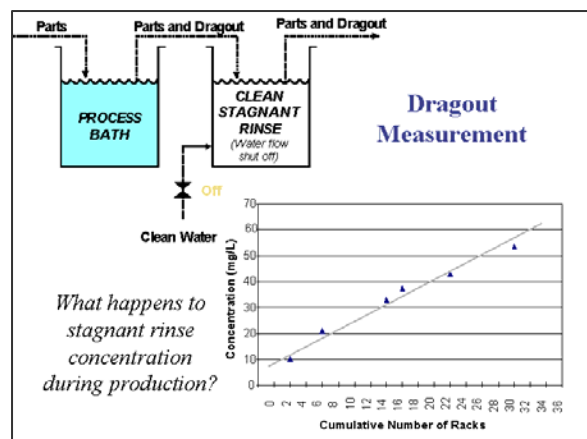

18. Controlling drag-out. The EPA video effectively illustrates worker techniques that can result in significant reductions in drag-out. The video, which you will receive, includes both English and Spanish language versions.

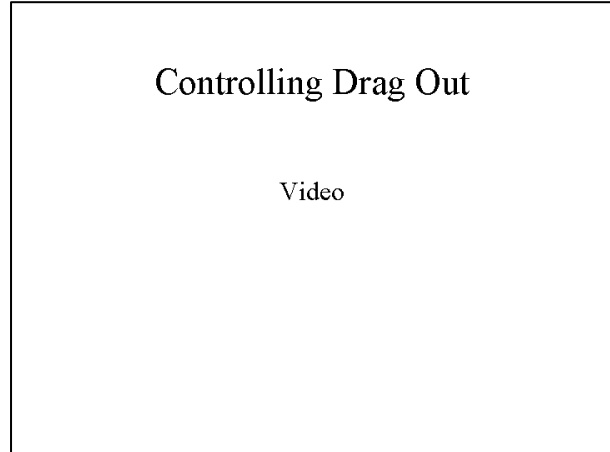

19. Drag out reduction – spray systems. One of the most effective methods to reduce rinse water usage is through the use of low-flow spray rinse systems. Positioning spray rinse systems over process baths returns chemicals to the bath and reduces the drag-out contamination of rinse tanks, extending useful rinse tank life.

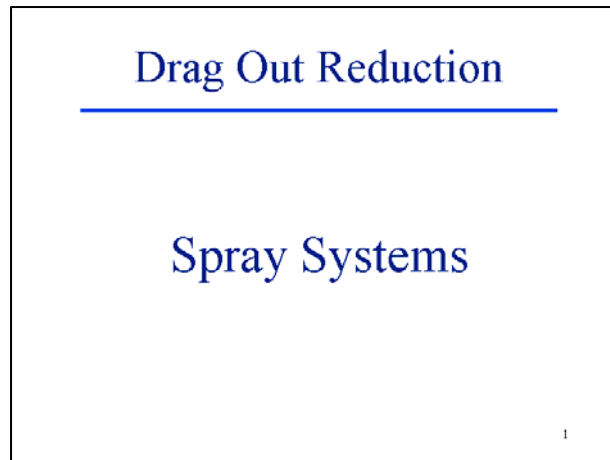

20. Spray rinse use. A National Association of Metal Finishers survey found that only 39% of shops were using spray rinses in 1995.

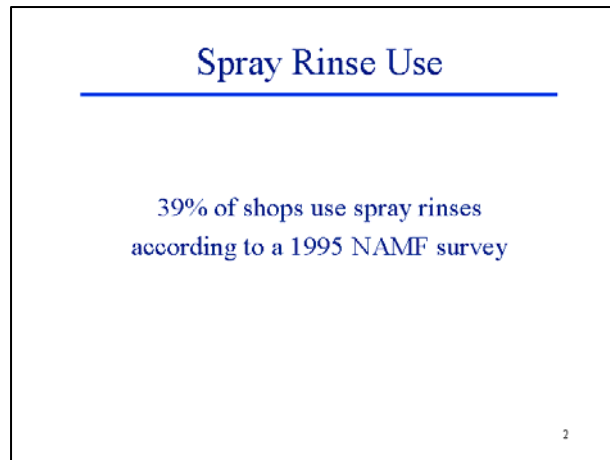

21. Components of a spray system.

Although the design of a spray rinse system is not complex, several components are required in a good design. A clean water source, followed by a filter assures trouble-free operation. An on-off switch, easily operated by the operator (e.g. foot switch), assures minimal water usage. A check valve prevents contaminated water from entering the rinse supply system and a spray nozzle with a flow rate and spray pattern selected for the rinse operation will assure effective rinsing and minimal water usage.

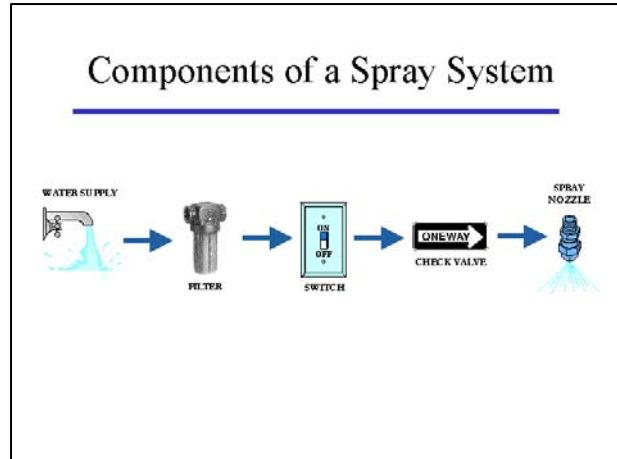

22. Spray nozzle patterns. Spray nozzles are inexpensive and a variety of spray patterns and flow rates are available.

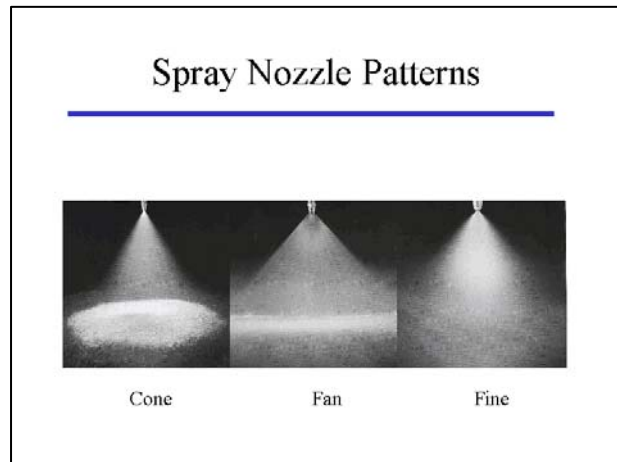

23. Case study: spray rinse systems. A job shop with chrome and nickel plating lines decided to implement spray rinsing to reduce rinse water usage and its associated costs.

The complex block is titled "Case Study: Spray Rinse Systems". It contains a "Facility Description:" section followed by a bulleted list of details:

- Customer base: plumbing hardware and miscellaneous small jobs
- Metal stamping
- Decorative chrome and nickel plating
- 23 employees
- 40-year-old facility

A small number "5" is located in the bottom right corner of the block.

24. Motivation for pursuing P2. Like many shops operating in a competitive market, profit margins were low. The company culture of continuous improvement motivated employees and management to look for ways to enhance competitiveness. By reducing rinse water usage, costs could be reduced for raw materials and wastewater treatment and disposal. Meeting wastewater limits and maintaining good relationships with the POTW also motivated the decision to pursue P2.

Motivation for Pursuing P2

- Competitive market: high volume, low profit margin
- Process control and efficiency
- Cost of raw materials and waste
- Compliance with wastewater limits
- Company TQM program
- Maintain good relationship with POTW

6

25. Nickel plating tank layout. A spray drag-out tank was installed after the nickel plating bath to remove much of the drag-out prior to immersion in a drag-out tank and rinse tank. Drag-out removed in the spray rinse tank was recycled back to the process bath, saving chemical costs and reducing the load to the WWTS.

Nickel Plating Tank Layout

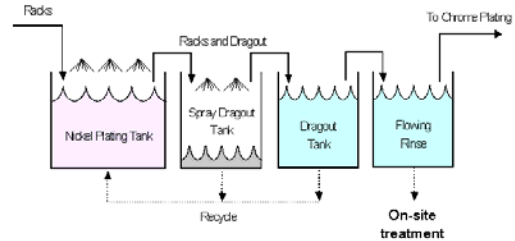

21

26. Spray rinse in drag-out tanks. The photograph illustrates the fine-mist, spray rinse process in the drag-out tank.

Spray Rinse In Drag-out Tanks



11

27. Sprays reduce nickel drag-out by 58%.
 The graph of conductivity in the rinse tank illustrates the impact of spray rinsing before immersion in the rinse tank. Nickel drag-in to the rinse tank was reduced 58% by spray rinse operations.

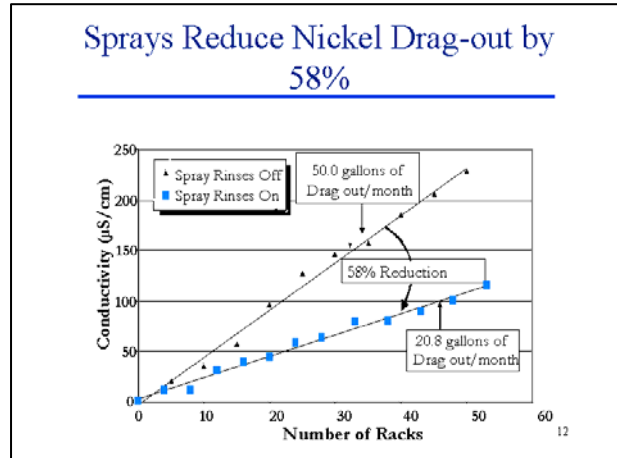

28. Chrome plating tank layout. Spray rinses were installed above the chrome plating tank and above two sequential flowing rinse tanks to reduce drag-out from the respective baths.

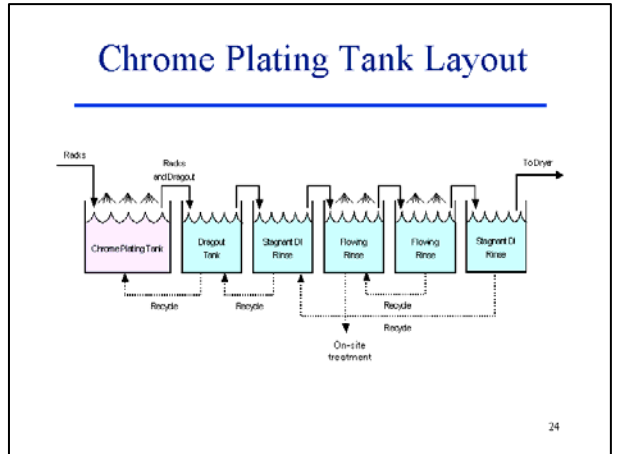

29. Spray rinses over chrome plating tank.
 These photographs illustrate the chrome plating tank before and after spray rinse installation. The spray rinse returned drag-out back to the process bath, reducing chemical losses.

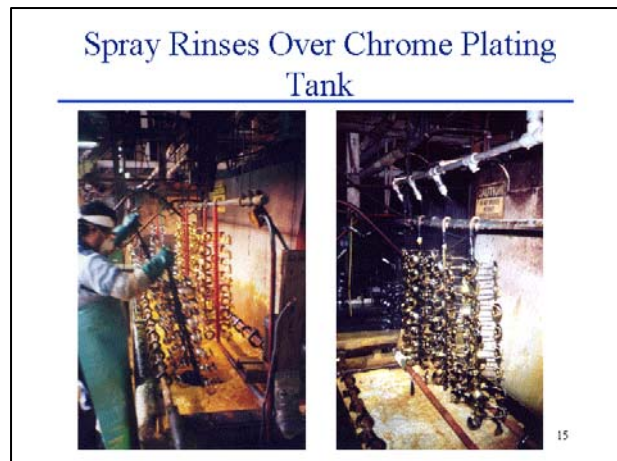

30. Monthly savings from drag-out reduction. This graph illustrates the savings realized in reduced chemical losses resulting from the spray rinses returning drag-out to the process tanks.

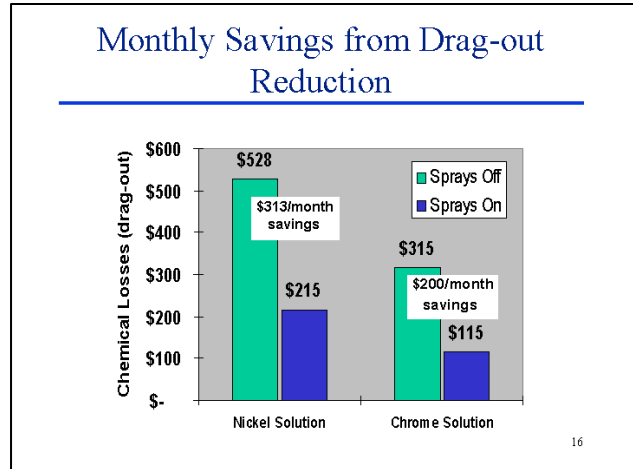

31. Spray rinse results. Reductions in volumes and costs for chemicals and rinse water are summarized in the table. The spray rinse system payback period was about 7 months.

Spray Rinse Results

	Without Sprays	With Sprays	Monthly Savings
Nickel Solution Drag out	50.0 gal/mo	20.8 gal/mo	\$313
Chrome Solution Drag out	63.1 gal/mo	23.0 gal/mo	\$200
Rinse Water*	380,000 gal/mo	152,600 gal/mo	\$185
Total Cost Savings = \$8,376/year			
Total Cost = \$4,890			
Payback Period = 0.6 year			

*Estimated based on drag out reduction

32. Using a spray system over process baths, whether using hand guns or hoist-mounted nozzles, is effective at not only recovering dragout and returning it directly to process baths, but also in lowering loading to rinses resulting in lower required flow rates. The ideal circumstance is to use spray rinses over heated baths where rinse water from spray rinses can replace evaporative losses. Sprays can even be used on hand-operated and automated hoists, as long as spray use is optimized.

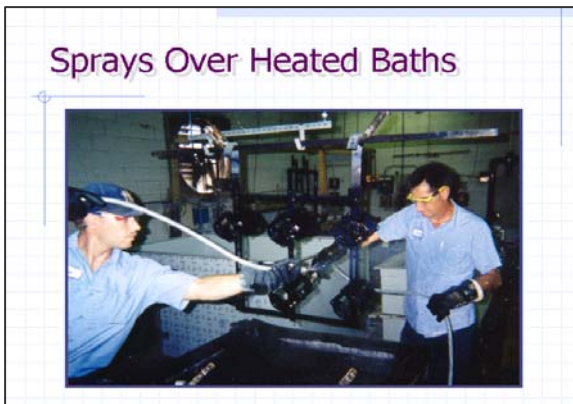

Drag-out recovery - Metal finishing and printed circuit board manufacturing facilities generate wastewater with high metal concentrations that must be treated before discharge. Most facilities use conventional wastewater treatment systems to precipitate metals out of solution, which creates a sludge that must be disposed of as hazardous waste. Expenditures associated with wastewater treatment and sludge disposal can create a significant operating cost for a facility.

Metals can be recovered from wastewater before conventional treatment by using ion exchange and electrowinning technology. Ion exchange systems capture metals in resin columns that are backwashed when saturated, which creates a low-volume, high-concentration regenerant waste stream. This regenerant can be processed through an electrowinner to recover elemental metals that can be reused or reclaimed. Electrowinners apply an electric potential to a set of cathodes and anodes, causing dissolved metals to migrate toward and plate onto the cathodes. Recovering metals from wastewater can reduce treatment system costs, including those for treatment chemical use and sludge generation and disposal. In addition, metal recovery from wastewater can reduce discharge of metals to sewer systems, helping facilities meet their discharge limits.

1. Drag-out recovery – electrowinning.
Metals from process baths are lost to the rinse tanks as drag-out each time a rack or barrel is transferred. The lost metals represent lost revenue, both in unused chemicals and in increased wastewater treatment and disposal needs. Recovering lost metals from the rinse tanks using the electrowinning process will be presented in this section.

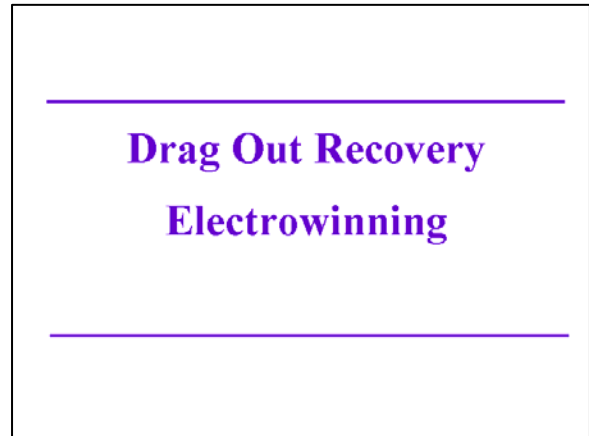

2. Hierarchy of P2 and waste management for metal finishing. Drag out recovery is the fourth of five pollution prevention strategies to be presented under the category of source reduction. By implementing strategies to reduce pollutant source quantities, metal finishers can realize cost savings and reduced pollution discharges.

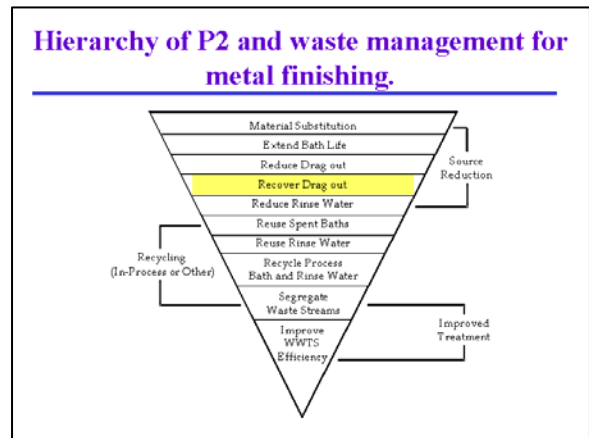

3. Electrowinning use. Electrowinning is most commonly used to recover metals from rinse tanks, often after the tank contents have been concentrated using a process such as ion exchange.

Electrowinning Use

- Used to recover metals from concentrated solution
- Most commonly installed on drag-out rinses
- 19% of shops use electrowinning according to a 1995 NAMF survey

4. Technology description. The electrowinning unit consists of a tank containing a series of cathodes and anodes. Target metals from the spent rinse water passed through the unit are reduced at the cathode to elemental metals. Cyanide is oxidized at the anode to harmless carbon dioxide and nitrogen gas. The process removes only select dissolved solids and carbonates and other ions may build up over time.

Technology Description

- Target metals reduced at the cathode
- Cyanide oxidized at anode
- Does not remove all dissolved solids
- Carbonates and other ions may build up over time
- Sizing: match plate-out rate to drag-out rate

5. Electrowinning process. The schematic illustrates the configuration of the cathode and anode plates and the manner in which water flows through the electrowinning unit.

Electrowinning Process

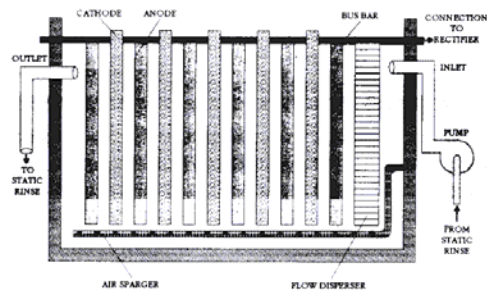

6. Electrowinning unit. The photograph illustrates the cathode and anode plates in an electrowinning unit and the electrical connections for one pole at the slots in the side of the tank. The electrical connections for the other pole are not visible in the photograph, but are located in slots on the other side of the tank.



7. Common applications.

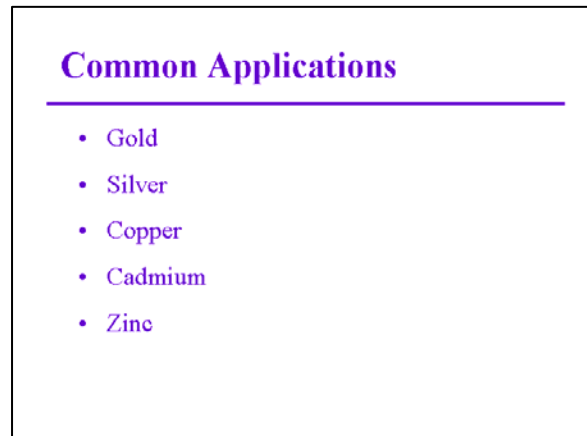

8. Cathodes and metal concentration. Two types of cathodes are used, flat plate and reticulated. Reticulated plates provide a larger cathode surface area within the unit. The deposition rate of target metals is proportional to the metal concentration in solution. Therefore, concentrating the metals using a process such as ion exchange prior to electrowinning will increase the metal deposition rate.

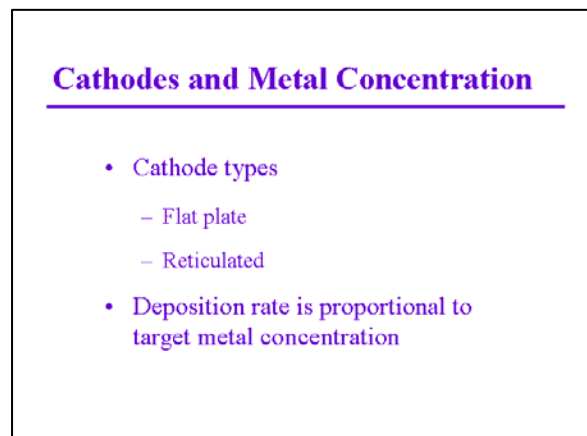

9. Case study. A small job shop specializing in cadmium, bronze, and zinc electroplating, as well as black oxide coating for aerospace and industrial customers was being pressured by the local POTW to reduce cadmium discharge concentrations from their facility. The shop decided to implement electrowinning to recover cadmium from their rinse tank cadmium line rinse tanks.

Case Study

Facility Description

- Small job shop
- Aerospace and industrial customers
- Specialize in:
 - Cadmium, bronze, and zinc electroplating
 - Black oxide coating
- Pressured by POTW to decrease discharge concentrations

10. Focus area. The cadmium line was targeted because it was the most frequently used process line and the largest source of heavy metals loading to the wastewater stream. The cadmium line consisted of three processes in series, cadmium cyanide electroplating, clear chromate conversion, and yellow chromate conversion. Rinsing followed each process.

Case Study

Focus Area

- Cadmium electroplating line
 - Most frequently used process line
 - Source of largest heavy metals loading to wastewater
 - Three processes:
 - Cadmium cyanide electroplating
 - Clear chromate conversion
 - Yellow chromate conversion

11. Phase I: tank layout. Prior to implementing the electrowinning process, tank layouts and configurations were modified. The revised configuration minimized distances between sequential tanks, eliminated common rinse tanks, and utilized counter-flow rinsing techniques. Phase one modifications also included installing drain boards to capture drag-out and return it to process baths.

Drag-out Recovery Case Study

Phase I: Modify Tank Layout

- Tank spacing and drain boards
- Tank sequence
- Drag out tanks (with or without sprays)
- Spray rinses

12. Tank layout – before. The schematic illustrates the tank layout before modification. The layout required several passes of dripping parts over process tanks, had large gaps between tanks and a shared rinse tank, guaranteeing cross contamination.

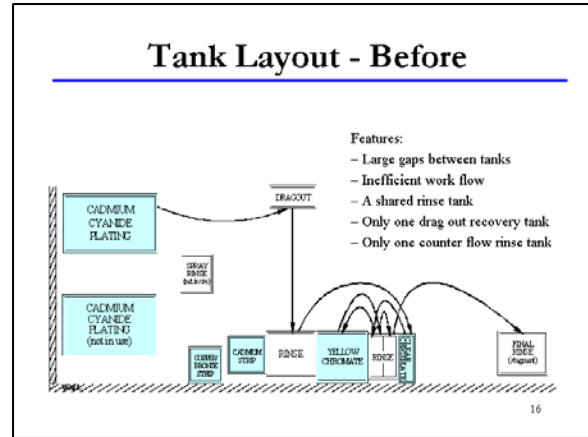

13. Tank layout – after. The schematic illustrates the improved work flow of the new tank configuration and the improved rinsing process.

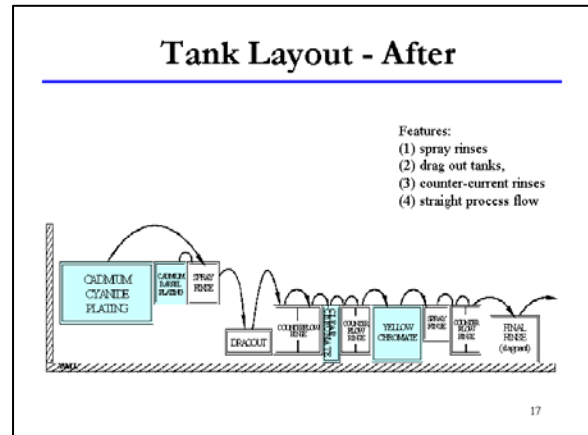

14. Tank layout modification results. The modifications resulted in reduced drag-out losses, reduced rinse water usage, improved rinsing, more efficient workflow, and reduced concentration of metals in WWTS discharge.

Case Study

Phase I: Results

- Drag-out losses reduced 50%
- Rinse water flow reduced 50%
- Improved rinsing
- More efficient work flow
- Lower concentration of metals in WWTS discharge

15. Tank layout modification results. This slide lists the savings resulting from drag-out reductions and the associated cost savings. The total cost is also listed and the payback period. The reduction in drag-out had a relatively low cost to implement and resulted in project payback within 1.73 years, with continued savings thereafter.

Tank Layout Modification Results

	Before <u>Modification</u>	After <u>Modification</u>	Cost <u>Savings</u>
Cadmium Cyanide Drag Out	18 gal/mo	9 gal/mo*	\$400/yr
Chromate Conversion Drag Out	123 gal/mo	62 gal/mo*	\$180/yr
Rinse Water	31,700 gal/mo	15,800 gal/mo	\$360/yr
Sewer Fee	31,700 gal/mo	15,800 gal/mo	\$1,400/yr
WWTS Chemicals		Not Quantified	
WWTS Filter Cake	200 lbs/mo	100lbs/mo*	\$240/yr
Total Cost Savings = \$2,620/year			
Total Cost = \$4,520			
Payback Period = 1.73 years			

*Estimated from *Perfect Rinsing* results

16. Phase II: Electrowinning. The schematic illustrates the cadmium process line configuration and the location of the electrowinning unit on rinse tank 1 following the cadmium cyanide plating tank. Rinse tanks 1, 2, and 3 are configured for counter-flow rinse operations, so rinse tank 1 has the highest concentration of cadmium and cyanide, making it the logical place for electrowinning installation.

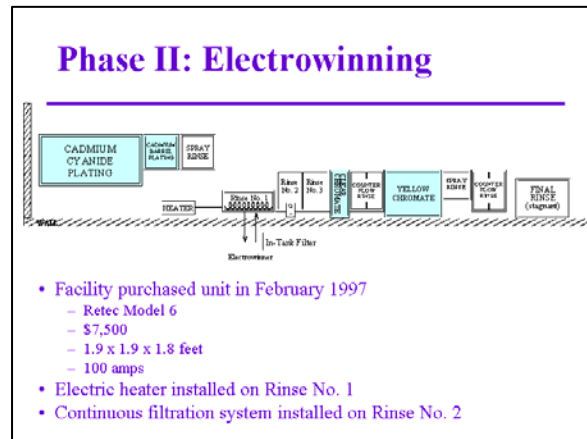

17. Electrowinning results. The process worked very effectively, reducing rinse water usage from 720 to 20 gallons per day.

- ### Electrowinning Results
- No negative impacts on rinse quality or rejects
 - 20 gallons per day of rinse water moved from Rinses No. 2 and 3 into Rinse No. 1
 - Rinse No. 1 dumped and batch-treated every 6 weeks
 - Rinse No. 3 maintained clean
 - Rinse water use
 - Before: 720 gal/day
 - After: 20 gal/day

Pollution Prevention Training for Pretreatment Inspectors

18. Electrowinning economics (including tank modifications). The payback period for the project is 3.3 years.

	Per Year		Annual Savings
	Before	After	
Cd Dragout	216 gal	108 gal	\$400
Water Use (Cd Process)	190,080 gal	3,960 gal	\$350
Sewer Fee (Cd Process)	190,080 gal	0 gal	\$1,440
WWTS O&M (Facility)	\$12,610	\$10,220	\$2,390
WWTS Sludge (Facility)	9,120 lb	8,420 lb	\$110
Total Cost Savings = \$4,690/yr			
Total Cost = \$13,530			
O&M Cost = \$530/yr			
Payback Period = 3.3 years			

Rinse Water Reduction - Rinsing is a critical component of the metal plating process. Costly part rejects can be caused by poor rinse water quality. Contaminants, not removed in rinse stages, can be carried over to subsequent process baths, diminishing plating quality and necessitating early process bath replacement. To prevent this costly occurrence, many metal finishers continually add flush water to rinse tanks to maintain high water quality in the tanks to help assure effective rinsing. Unfortunately, this practice results in costly, high water usage rates, and high wastewater generation rates. Pollution prevention methods designed to reduce water usage can reduce costs and improve rinse quality, a win-win for metal finishers and the environment.

1. Pollution prevention – optimizing rinse operations. Rinsing is one of the most important processes in metal plating. It affects product quality and wastewater generation. By optimizing rinsing operations, shops can reduce reject rates, reduce wastewater generation rates, and reduce costs!

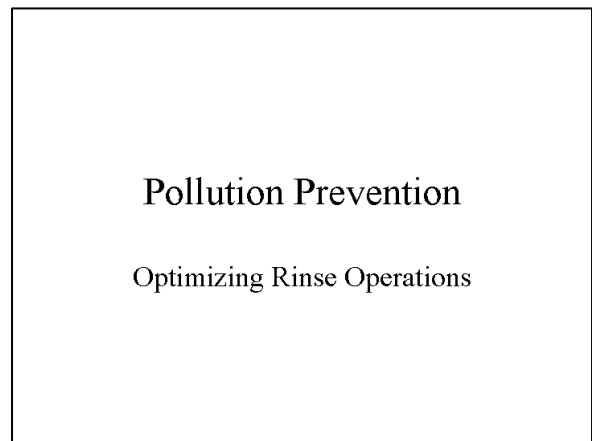

2. Hierarchy of P2 and waste management strategies for metal finishing. The last P2 practice in the category of source reduction, reducing rinse water usage, will be presented in this unit.

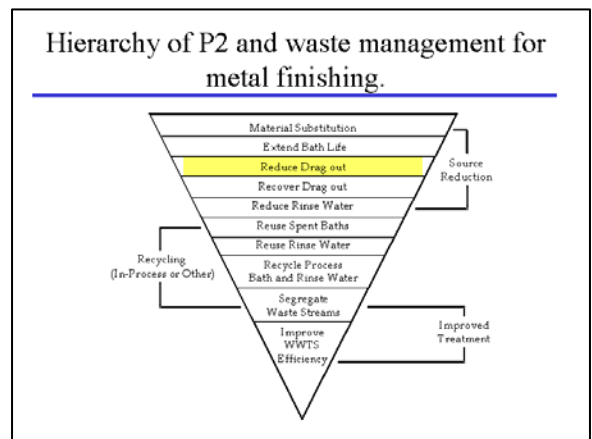

3. Rinsing perspectives. Three perspectives can be applied to rinsing operations, quality, financial, and environmental. Although it is common to think of rinsing from any one of these perspectives, they are all interrelated. Any changes made in rinsing practices will have an impact on quality, cost, and environment.

Rinsing Perspectives

- *Quality Perspective:* Removing chemicals (drag-out) from parts between process operations is critical
- *Financial Perspective:* Reject and rework is costly; wastewater treatment is also expensive
- *Environmental Perspective:* Water is a scarce and valuable resource and dirty rinse water is a major hazardous waste stream

4. Rinse water quality. It is routine in the metal plating industry to monitor process baths. However, rinse water is often left unmonitored, then dumped in response to declining plating quality. By monitoring rinse water, its quality and life cycle can be optimized, improving product quality and reducing the volume of wastewater and thereby the cost for wastewater treatment and disposal.

Rinse Water Quality

- Rinsing is a process that can and should be monitored
- Affects finish quality and drag-in to “downstream” tanks
- Costs \$ to treat spent rinse water

3

5. Impacts of poor rinse quality. Poor rinse quality results in contaminant carry over into subsequent process baths, diminishing bath quality and reducing the life of those baths. Resultant impurities on part surfaces diminish visual appearance and prompt dumping and replacement of process bath and rinse tank contents, generating wastewater. Increased wastewater generation can have significant cost impacts, both capital and O & M.

Impacts of Poor Rinse Quality

- Increased drag-in of contaminants into next bath
- Creates impurities on parts surface
- Reduced visual appearance of parts
- Increased wastewater treatment costs
 - Capital
 - O & M

4

6. NAMF survey results on rinse system design. National Association of Metal Finishers survey results indicate that about 2/3 of respondents are controlling rinse water flow rates manually. Although a high percentage use flow restrictors to reduce water usage, manual control has the potential for water wastage, especially when quality is not monitored.

**NAMF Survey Results
on Rinse System Design**

- 58% to 70% of respondents claim use of:
 - Manual control of rinse water flow rates (66%)
 - Flow restrictors (70%)
 - Countercurrent rinse system designs (68%)
 - Rinse tank agitation (58%)
- Less than 40% of respondents claim use of:
 - pH or conductivity controls (16%)
 - Flow meters to measure water use (12%)
 - Spray rinses (39%)

7. Components of effective rinsing. Effective rinsing has three components, dilution, contact time, and scrubbing. Optimizing effective rinsing involves utilizing all three components. This is accomplished by having “clean” rinse water, providing adequate dwell time in the rinse cycle, and providing agitation.

Components of Effective Rinsing

- Turbulent flow around part (scrubbing)
- Adequate contact time between the part and the rinse water
- Adequate dilution so that drag-out from rinse tank does not affect subsequent operation

8. Maximizing rinse efficiency. This figure represents the three components of effective rinsing. Combining all three orientates one in the center of the figure where maximum rinsing effectiveness occurs. Providing one or two components moves one out of the maximum effectiveness zone and into an area of lower rinse effectiveness.

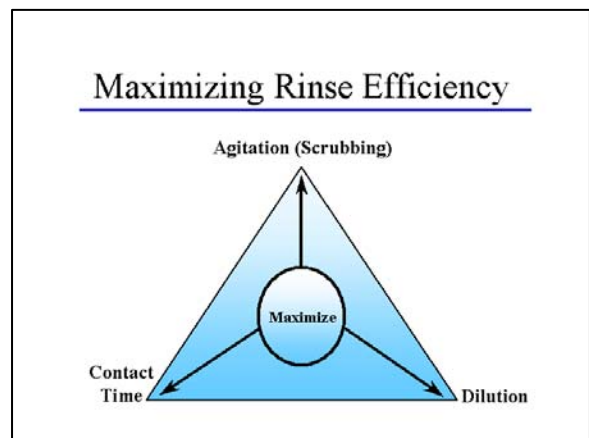

9. Techniques that improve rinse efficiency. Agitation can be accomplished with rack motion, aeration, sprays, and double dipping – any action that provides turbulence around the part to move contaminants away from the part and out of the area of local higher concentration adjacent to the part surface. Tank layout can improve rinse efficiency by maximizing dilution. Multiple rinses and counter flow rinsing techniques provide much greater dilution than a single rinse.

Techniques that Improve Rinse Efficiency

- Agitation
 - Rack motion
 - Forced air and/or forced water
 - Sprays
 - Double dipping
- Tank Layout
 - Multiple rinse tanks better than single rinse tank
 - Countercurrent rinses are extremely efficient (90% reduction compared to a single flowing rinse) but most shops do not accommodate the larger "footprint"

8

10. Techniques that improve rinse efficiency (continued). Tank design is critical to effective rinsing and pollution prevention. Tanks should be sized to accommodate parts. Oversized tanks create larger than necessary waste loads when they are dumped. Maintaining high quality water by adding the minimum amount of make-up of dilution water will optimize rinsing effectiveness and minimize pollutant discharge. Flow restriction on rinse water supply lines and feed controls such as conductivity controlled feed valves help maintain high rinse water quality while minimizing water usage. Using high quality water, such as deionized water, provides more effective rinsing than tap water.

Techniques that Improve Rinse Efficiency (continued)

- Tank Design
 - Size (not bigger than necessary)
 - Locate inlets and outlets to maximize mixing and eliminate short-circuiting
- Flow Controls and Water Quality
 - Flow restrictors
 - Conductivity control systems
 - Use warm or hot water, if possible
 - Use deionized water rather than tap water, if possible

9

11. Benefits of rinse water use reduction. Reducing rinse water use results in reduced water and sewer fees, reduced wastewater treatment costs (capital and O & M), and decreased sludge generation – all cost savings and pollution prevention.

Benefits of Rinse Water Use Reduction

- Lower water bills and sewer fees
- Wastewater treatment impacts
 - Reduced treatment chemical costs
 - Increased treatment retention time
 - Reduced O&M requirements
- Decreased sludge generation

Pollution Prevention for Pretreatment Inspectors

12. Total cost of water use. The cost of water is not limited to the fee for the water. It also includes fees for wastewater disposal, and O & M costs for wastewater treatment plus sludge disposal fees. Because more dilute wastewater is more difficult to treat, high chemical usage rates and costs are incurred when more rinse water is used and more chemical sludge is produced. The listing on this slide summarizes the increased costs associated with increased rinse water usage and illustrates that those costs are greater than just the water fee.

<u>Total Cost of Water Use</u>	
	<u>Unit Cost</u>
Water purchase (Northern Cal.)	\$1.00 to \$2.60 per 1,000 gal
Wastewater sewer fee (Northern Cal.)	\$0.70 to \$3.50 per 1,000 gal
WWTS chemical and labor costs	\$12.00 per 1,000 gal
Total (not including sludge disposal cost)	\$15.90 per 1,000 gal
Sludge disposal	\$.25 to \$.50 per pound

13. Typical water reduction savings. A metal finishing shop instituting pollution prevention practices reduced its rinse water usage by 25%, from 400,000 gal/mo to 300,000 gal/mo. By accomplishing that water usage reduction, the company saved \$1,620 per month.

<u>Typical Water Reduction Savings</u>			
	<u>Monthly Cost</u>		<u>Monthly Savings</u>
	<u>Before</u>	<u>After</u>	
Water purchase	\$600	\$450	\$150
Sewer fee	\$300	\$230	\$70
WWTS O&M	\$4,800	\$3,600	\$1,200
Sludge disposal	\$1,900	\$1,700	\$200
	Total Savings =		\$1,620/mo

14. Methods of reducing rinse water usage. Several proven methods exist to reduce rinse water usage. Foremost is to reduce drag-in by increasing “hang time” of parts over the chemical tank before moving them to the rinse tank. This technique reduces drag-out chemical loss from the process baths and drag-in contamination to the rinse tanks, which extends the useful life of the rinse water, reducing the need to replace rinse water. Modifying flow-through rinse systems by monitoring water quality and only adding water when necessary and by incorporating counter flow rinse water reuse reduces water usage. Purifying and reusing rinse water, rather than disposing of it, also reduces rinse water usage.

<u>Methods for Reducing Rinse Water Usage</u>	
<ul style="list-style-type: none"> • Reduce drag-in from process tanks • Modify “flow-through” rinse systems <ul style="list-style-type: none"> – Monitor and control water addition – Utilize multi-stage rinse tanks with “counter-flow” rinse water reuse • Purify and reuse rinse water <ul style="list-style-type: none"> – Dialysis – Ion exchange – Electrowinning 	

15. Rinse water feed control using conductivity. One method of monitoring and controlling rinse water quality is by use of continuous conductivity measurement. Conductivity measurement can be used to both monitor the water quality and control the addition of dilution water to maintain a selected level of rinse water quality. By adding water only when it is needed to maintain the selected quality level, water usage is minimized without sacrificing process quality.

Rinse Water Feed Control Using Conductivity

- Purpose: Implement conductivity control systems to reduce rinse water use
- Approach:
 - Monitor rinse tank water conductivity
 - Add water only when conductivity exceeds set-point value
 - Monitor system performance

14

16. Conductivity. Conductivity measures the ability of an aqueous solution to carry electric current, which correlates directly to the concentration of free ions in solution. Free ions result from chemicals rinsed from parts and dissolved in rinse water solution. By measuring conductivity, the concentration of dissolved chemicals in the rinse water can be inferred and water quality monitored and controlled.

Conductivity:

- A measurement of the ability of an aqueous solution to carry electric current ($\mu\text{S}/\text{cm}$).
- Correlates directly to the concentration of free ions in solution.
- Can be used to infer the dissolved ion concentration in solution.
- Can therefore be used to monitor water quality in rinse tanks and activate rinse water feed to those tanks to maintain water quality.

17. Typical continuous flow rinse tank. This schematic illustrates a typical flow through rinse tank configuration. Parts are processed through the rinse tank, depositing chemicals in the rinse water. Fresh rinse water is continually added to maintain high quality water in the tank, and spent water continually exits the tank and is piped to the wastewater treatment facilities. This configuration results in high water usage, high wastewater generation rates, and high costs.

Typical Continuous Flow Rinse Tank

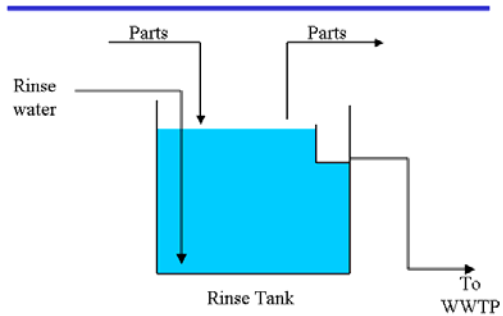

18. Conductivity flow control. This schematic illustrates the same tank, retrofitted with a conductivity control system for rinse water quality monitoring and control. The conductivity sensor in the water sends a signal to the analyzer. When the analyzer reads a conductivity that is within selected water quality parameters, it keeps the solenoid valve on the water feed line closed. When conductivity exceeds the selected level, the analyzer/controller opens the valve to add water to the tank until the conductivity is once again within the prescribed range, when it once again stops water flow. This system maintains high quality water in the rinse tank, while minimizing water usage.

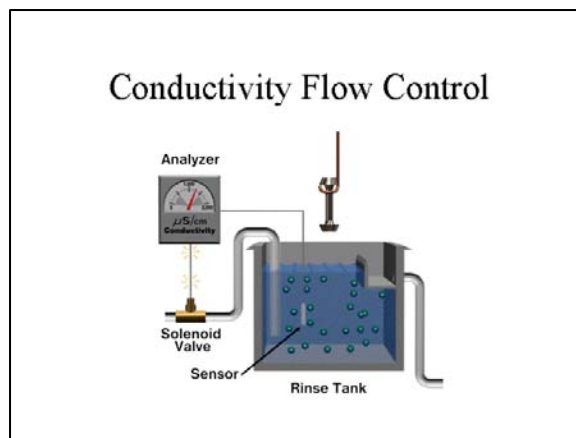

19. Rinse water flow control. This graph illustrates the conductivity measurement and water addition accomplished by the conductivity analyzer/controller.

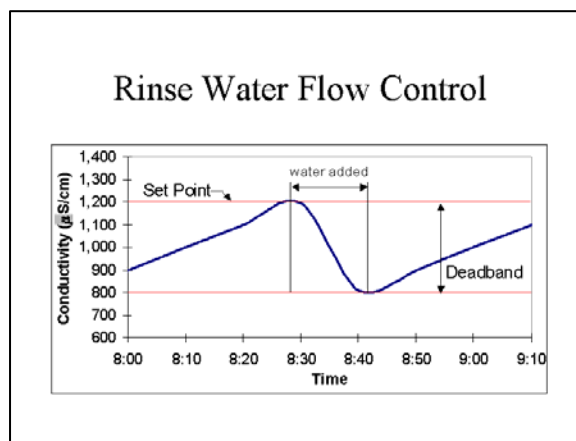

20. There are two types of conductivity sensors that can be used in a conductivity controlled rinsing system: conventional and electrodeless. Conventional sensors use a small electrical charge applied between two electrodes to measure the conductivity of a solution. These sensors are designed for intermittent use in laboratory testing of relatively “clean” solutions. Significant fouling of the electrodes is common when conventional sensors are used in continuous industrial applications such as metal finishing rinse tank monitoring.

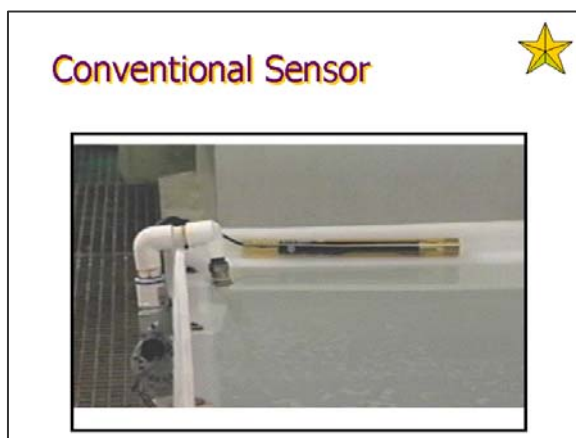

21. Electrodeless sensors encase two parallel torroids in non-conductive casing to measure conductivity inductively. While more expensive, the electrodeless sensors do not foul and therefore are significantly more reliable to operate and maintain for metal finishing applications.

Electrodeless Sensor 

- ◆ Uses two parallel torroids
- ◆ Non-conductive casing (polypropylene or PVDF)
- ◆ No electrodes; no fouling
- ◆ Can measure full range of conductivity

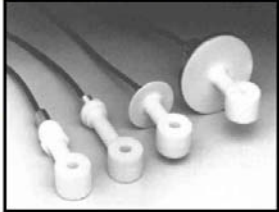

22. Either type of sensor should be located in the tank to avoid “hot spots” and clean water inlets.

Electrodeless Sensor 



23. Case study: Conductivity control system for rinse water usage. A metal finishing shop with brass, copper, nickel, and chrome lines instituted conductivity control systems in an attempt to reduce rinse water usage.

Case Study: Conductivity Control System for Rinse Water Usage

Metal Finishing Facility Description:

- Sports, plumbing, automotive hardware
- Specializes in electroplating zinc die-cast parts
 - Also electroplates steel and brass parts
- Hand Operated Rack Line
 - Brass, copper, nickel, chrome
- Manually-Operated Barrel Hoist Line
 - Copper
- 60 employees

19

Pollution Prevention for Pretreatment Inspectors

24. Baseline rinse water costs. Base line rinse water costs prior to implementation of the conductivity controls systems were \$8,100/mo. Baseline costs included water purchase, wastewater treatment and disposal, and sludge disposal.

Baseline Rinse Water Costs		
	<u>Monthly Rate</u>	<u>Monthly Cost</u>
Rinse Water Use	520,000 gal	\$640
Wastewater Discharge	520,000 gal	\$260
WWTS Operation	520,000 gal	\$5,800
Sludge Generation	2.6 tons	<u>\$1,400</u>
Total =		\$8,100

20

25. Rinse water use. The plot of weekly rinse water use clearly illustrates the effect of implementing the conductivity control system on rinse water usage rate.

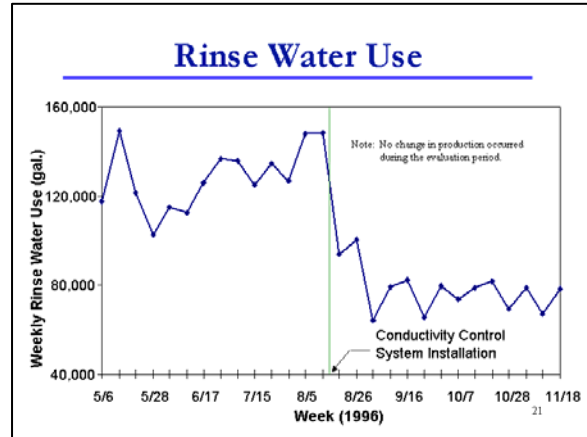

26. Conductivity control system results. Cost savings that resulted from the reduction in water usage, not including decreased sludge production, was \$14,300/yr. The cost to implement the system was \$14,500. The system, therefore, paid for itself within one year and the facility went on to realize \$14,300/yr saving thereafter.

Conductivity Control System Results			
	<u>Per Month</u>		<u>Monthly Savings</u>
	<u>Before</u>	<u>After</u>	
Rinse Water Use	516,000 gal	296,000 gal	\$280
Wastewater Discharge	516,000 gal	296,000 gal	\$110
WWTS Chemical Use	\$4,000	\$3,200	\$800
WWTS Sludge	Not Quantified		
Total Cost for Nine Systems = \$14,500			
Total Cost Savings = \$14,300/yr			
Payback Period = 1.0 year			

22

27. Video – conductivity. The following video illustrates the results experienced by one facility implementing a conductivity control system for rinse water addition.

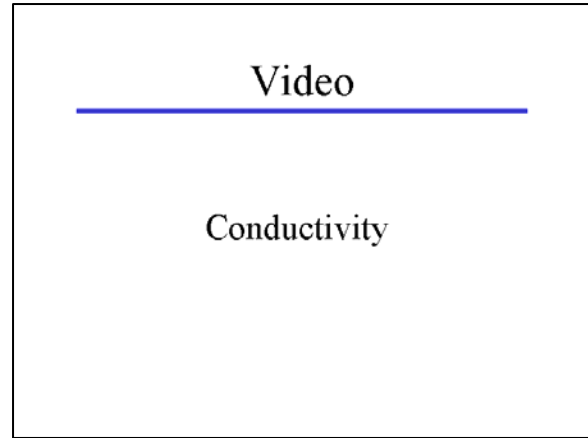

Reusing spent baths – Plating baths are the heart of the metal plating process. When the efficiency of a bath degrades, the contents are dumped and a fresh bath is made-up. Dumping spent baths generates high concentration wastewater, which must be treated. Making up new baths requires fresh chemicals and water. Costs are incurred from the spent bath dumping, treatment, and disposal, and from the down time, labor costs, and bath components for making up a new bath. Obviously, hazardous wastes are generated from the spent bath dumping. Regenerating spent plating baths can extend the life of plating baths, ultimately reducing the total number of bath replacements required, reducing waste generation and operating costs.

1. Process bath preservation, metal recovery.
This unit will focus on the use of electro dialysis technology to recover metal from electroless nickel plating baths to enable reuse of the bath and delay bath disposal.

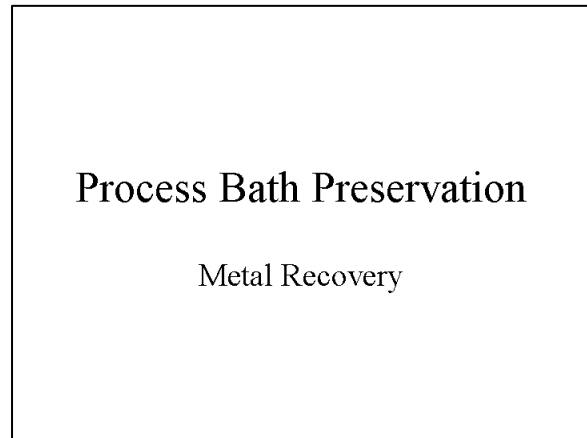

2. Hierarchy of P2 and waste management strategies for metal finishing. This unit will focus on technology that enables reuse of spent plating baths.

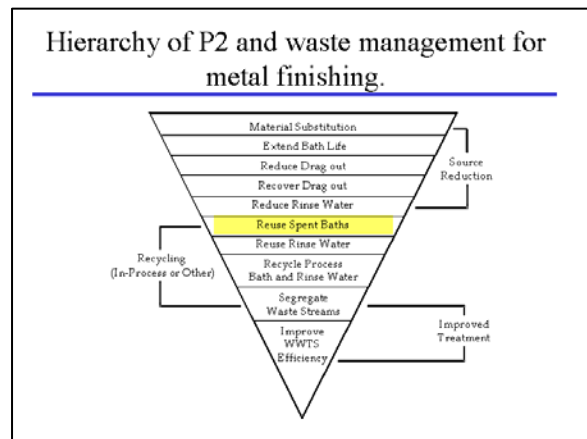

3. Electroless nickel plating chemistry. The electroless nickel plating process uses chemical oxidation of hypophosphite to reduce nickel ions to elemental nickel metal that is plated onto parts. The process is pH sensitive and requires buffer chemicals to maintain pH within a narrow operating range.

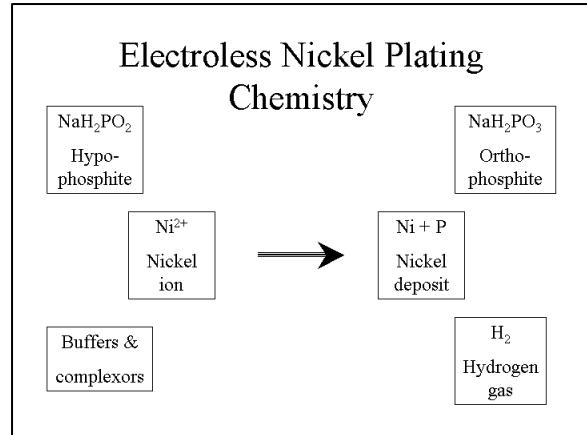

4. Electroless nickel plating process. Bath use in the electroless nickel plating process is measured in metal turnovers (MTOs). One MTO = use of all nickel in the plating bath. Because metal salts are regularly added to the bath, all of the nickel is not used up as a batch, but rather the plated volume is measured against the total nickel added to determine MTOs. As the bath ages, the deposition rate decreases and plating efficiency drops.

- ### Electroless Nickel Plating Process
- Uses chemical oxidation to produce a nickel deposit on parts
 - Bath use is measured in metal turnovers (MTOs)
 - 1 MTO = Plating all Ni contained in one bath
 - Metal salts are added to replace plated Ni
 - Deposition rate decreases as bath ages

5. Nickel plating efficiency. The graph illustrates the decrease in nickel deposition rate as a function of metal turnovers in the plating tank.

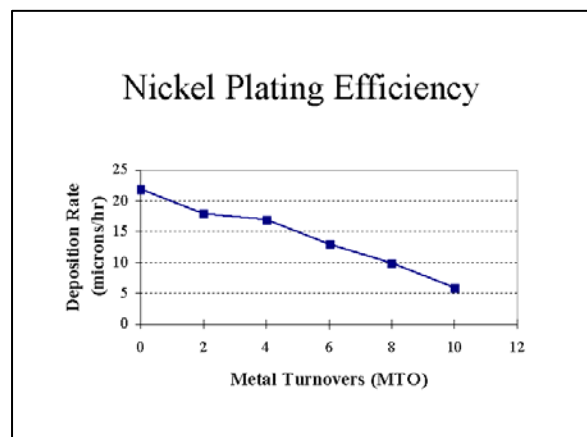

6. When efficiency degrades, bath is dumped. The impacts of dumping a spent electroless nickel bath are listed and the cost of those impacts emphasized. The costs are of utmost concern to metal finishers and the only reason the decision to dump and incur those costs is made, is because more money is lost by keeping an inefficient bath in service.

When Efficiency Degrades, Bath is Dumped

- Impact of bath dumping
 - Nickel, hypophosphite, buffers, & complexors are lost (cost for fresh chemicals).
 - Dumped chemicals must be treated (treatment and disposal costs are incurred).
 - Chemical loads to the POTW and environment are increased.
 - New bath must be aged (lost time = lost \$\$)

7. Alternative to frequent bath dumping: electro dialysis. This schematic of the electro dialysis illustrates the cleaning process. Bath liquid is passed through the electro dialysis unit and undesirable constituents are selectively removed from the fluid through membranes, returning purified fluid to the EN bath. The next two slides describe the process in more detail.

Alternative to Frequent Bath Dumping: Electro dialysis

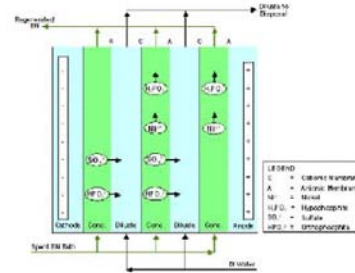

8. Electro dialysis technology description. The electro dialysis unit consists of semi-permeable, ion selective membranes. Electrical current applied across the membranes selectively attracts charged ions across the membranes and out of the bulk solution flowing through the unit, thereby removing the unwanted ions from solution.

Electro dialysis Technology Description

- Selectively removes undesirable constituents from process baths
- Semi-permeable, alternating cation -and anion-selective membranes
- Electrical current applied across the membranes cause ion migration

9. Electrodialysis technology description. The selective membranes in the unit produce two effluent streams, a concentrated stream containing metal plating ions, and a dilute stream containing bath contaminants. The concentrated metal ion stream is returned to the bath for continued plating use, rather than being lost to disposal in a bath dump. The process extends the useful life of the bath and recovers metal ions for use in plating, preventing it from becoming part of the waste stream.

Electrodialysis Technology Description

- Migrating ions are separated by the ion-selective membranes
- Two effluent streams
 - Concentrate stream – contains metal plating ions; reused in bath
 - Diluate stream – contains bath contaminants; disposed.

10. Case study – extending electroless nickel bath life using electrodialysis.

Case Study

Extending Electroless Nickel Bath Life Using Electrodialysis

11. Facility description. This case study was conducted at a medium sized metal finishing shop in Arizona with three electroless nickel plating tanks.

Case Study

Facility Description

- Medium-sized metal finishing job shop in Phoenix, AZ
- 5 primary process lines
 - copper, tin, and EN plating
 - zinc plating
 - anodizing and conversion coating,
 - zinc phosphate
 - bright nickel
- Three 170-gallon EN plating tanks

12

12. An electro dialysis unit, with a capital cost of \$28,000, was installed. The unit was capable of regenerating an EN bath with 6 MTOs to the equivalent of 1 MTO in 60 hours. The specifications for the electro dialysis equipment are listed.

Case Study

Full-Scale Implementation

- 60 hours to reduce 170-gallon bath used for 6 MTOs to 1 MTO equivalent
- 30 diluate and concentrate compartments
- 21 amps of electrical current
- 380 watts per hour of electrical power
- Footprint: 2' x 4'
- Height: 4.5'
- Capital Cost: \$28,000

13

13. Full-scale electro dialysis unit. The process worked so effectively with a demonstration unit during the study that the company decided to implement the technology and purchased a full-scale unit, shown in the photograph.

Case Study

Full-Scale Electro dialysis Unit

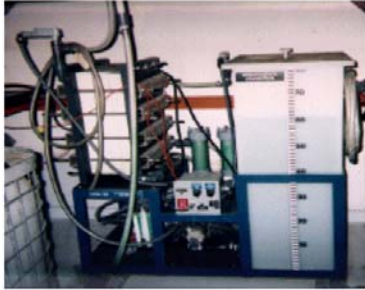

14

14. Electro dialysis influent and effluent streams. This “black box” schematic illustrates the volumes of the influent and effluent streams.

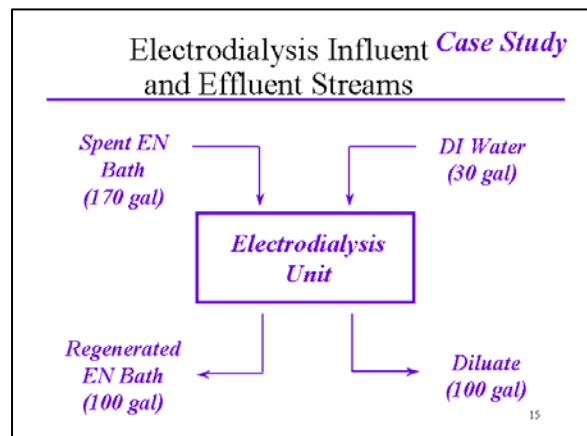

15. Operation and maintenance. Performance and O & M requirements and observations are listed, along with labor requirements, which are needed to perform a cost – benefit assessment.

Case Study

Operation and Maintenance

- 60 hours to regenerate 170 gallons; 2.5 hours of staff labor
- 1-micron pretreatment filters, changed every 3 months
- Membranes cleaned every 3 months using nitric acid; requires 2 hours of staff labor
- Three months of shakedown time
- Solid, plastic fittings and plumbing less prone to leaking than flexible fittings and hoses
- Effectiveness monitored by performing nickel, hypophosphite, and orthophosphite analyses

16

16. EN plating comparison. The effectiveness of the electro dialysis process in reducing bath dumps and associated costs is clearly illustrated in the table. Plating quality increased and waste generation and costs decreased.

Case Study

EN Plating Comparison

Parameter	Before Electro dialysis	With Electro dialysis
New EN Baths Per Year	71	3
Electro dialysis Regenerations Per Year	---	77
Total Liquid Waste Solution Per Year	12,070 gallons	6,840 gallons
MTOs Per Bath	5 to 6	60
Reject Rate - Cost	\$20,400	\$6,280

17

17. Results.

Case Study

Results

- Total EN process chemical use decreased by 25%
- Total liquid waste generation decreased by 33%
- Total liquid waste disposal cost decreased by 77%
- Significant decrease in “break-in” time
- Reject rates decreased 50%
- Total mass of nickel waste decreased by 56%
- Normal EN bath additions remained unchanged

18

Pollution Prevention Training for Pretreatment Inspectors

18. Annual costs. The tabulated costs, before and after electro dialysis implementation, clearly illustrate the cost savings realized by implementing the pollution prevention technology.

Case Study

Annual Costs

Parameter	Before Electrodialysis	With Electrodialysis
EN Bath Operation		
New Bath Make-Up Chemical Cost	\$37,630	\$1,590
EN Chemical Additions	\$43,380	\$43,380
Spent Bath Treatment and Disposal	\$31,740	\$1,340
Labor for Make-Ups	\$1,780	\$75
EN Rejects	\$20,400	\$6,280
Electrodialysis O&M		
Regeneration Additions	---	\$15,550
Dilute Disposal	---	\$5,930
Labor - Regen. and Membrane Clean	---	\$400
Electricity	---	\$160
TOTAL	\$134,930	\$84,340

21

19. Payback period. Significant total annual savings were realized with the electro dialysis technology, which yielded a 7-month payback period.

Case Study

Payback Period

Total annual savings = \$50,600/year

Total capital cost = \$28,225

Payback period = 7 months

22

Rinse water reuse. Spent rinse water constitutes the major fraction of wastewater generated by metal finishing shops. Reducing the volume of disposed rinse water is a major component of pollution prevention efforts. By devising methods to economically reuse rinse water, rather than disposing of it, significant cost savings can be realized in avoided water purchase and in waste treatment and disposal costs. This unit will focus on economical methods of reusing rinse water to reduce costs and environmental impacts

28. Rinse water reduction by rinse tank reconfiguration. Significant improvement in rinse quality, coupled with reduction in rinse water usage can be accomplished by rinse tank reconfiguration. Examples are converting from a single rinse tank to multiple tanks in series and tanks in series with counter flow.

Rinse Water Reduction by Rinse Tank Reconfiguration

- Single rinse tank, continuous flow
- Multiple rinse tanks in series
- Multiple rinse tanks with counter-flow

29. Hierarchy of P2 and waste management for metal finishing. Reuse of rinse water can have a profound impact on the quantity of wastewater generated by a metal finishing shop. Rinse water disposal comprises the largest volume of wastewater generated. By reusing rinse water and thereby reducing the volume wastewater generated, metal finishing shops can reduce costs for water purchase, wastewater treatment and disposal.

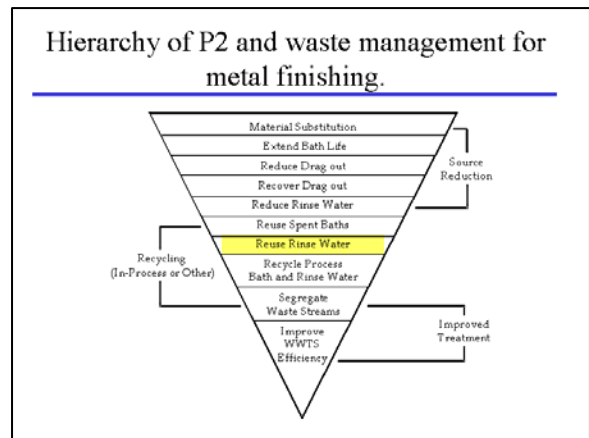

30. Single rinse tank, continuous flow. This schematic illustrates a single rinse tank with continuous flow through the tank to maintain high rinse water quality.

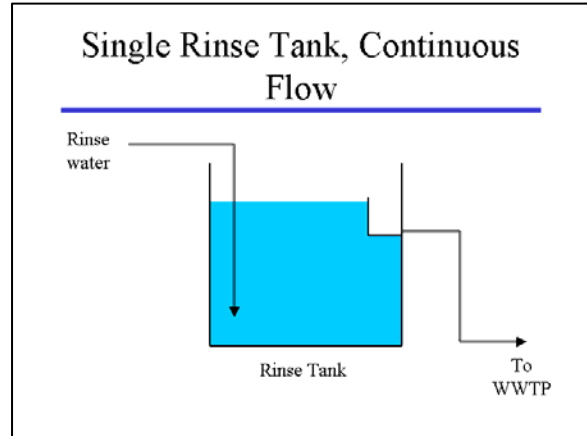

31. Rinse tanks in series. By placing a second rinse tank in series with the first rinse tank, rinse quality is improved because the first stage rinse significantly reduces the concentration of drag-in to the second tank. Combined water flow to both tanks can be maintained at a lower rate than the flow to a single rinse tank and higher rinse water quality maintained in the last rinse tank. Water usage is reduced and rinse quality is improved.

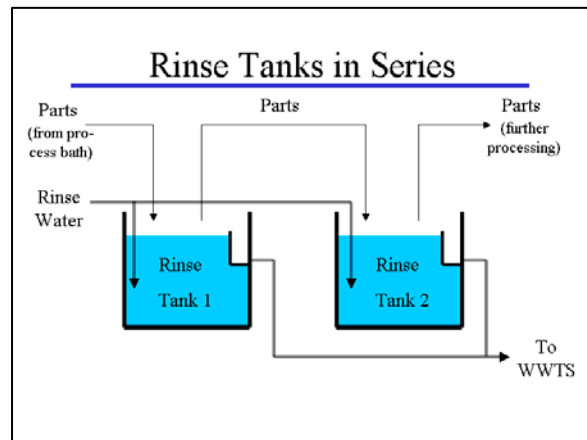

32. Counter-flow rinse tanks. By adding fresh rinse water to the last tank only in a rinse tank series and by taking spent rinse water from that last tank and using it as add water for the upstream rinse tank, the “counter - flow” rinse configuration is accomplished. Spent rinse water from the first rinse tank is the only spent rinse water sent to waste. This configuration enables all fresh rinse water to be sent to the last rinse tank, the one requiring the highest rinse quality, and allows for further reduction in water addition quantities to maintain high rinse water quality in the last rinse tank

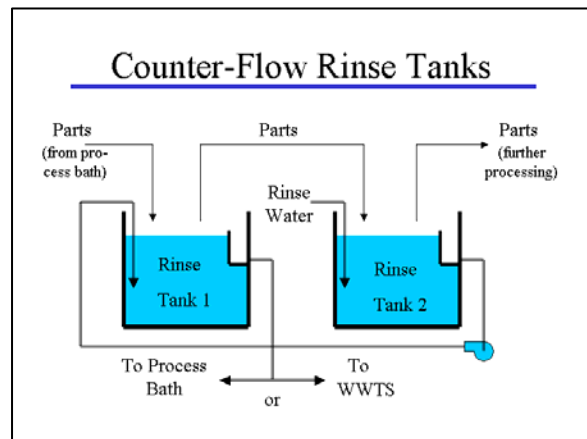

33. Rinse water flow rates required to maintain same final rinse concentration. This table illustrates the potential savings in water usage by utilizing rinse tank reconfiguration and counter-flow rinse implementation. Flows listed are those required to maintain the same rinse water quality in the last rinse tank for each configuration listed.

Rinse Water Flow Rates Required to Maintain Same Final Rinse Concentration

Type of Rinse	Single	Series		Counter-flow	
No. of Rinses	1	2	3	2	3
Rinse Water Flow Rate (gpm)	10.0	1.8	0.8	1.0	0.3

34. 1991 PF survey results on counter-flow rinsing. A 1991 survey of production facilities utilizing counter-flow rinsing shows that the majority realized 50% or greater reductions in rinse water usage rates.

1991 PF Survey Results on Counter-flow Rinsing

Reported water reduction from a 2-stage counter-flow rinse compared to single stage rinse based on survey of 250 metal finishing facilities

<u>Percent Water Reduction</u>	<u>Percent of Facility Responses</u>
25%	12%
50%	25%
75%	19%
90%	15%
99%	3%

35. Reactive rinsing uses counter-flow rinsing to take advantage of consecutive acidic and alkaline baths and the intervening rinse baths to achieve in-process neutralization. Three benefits result: lower rinse water use, improved rinsing, and reduced drag-in to the acid etch. The lower pH effluent from the rinse tank following the acid etch is used as influent rinse water for the rinse tank following the alkaline cleaner. It acts to neutralize the alkaline film at the part surface, achieving in-tank neutralization in the alkaline rinse and lowering the pH of the drag-in to the acid etch.

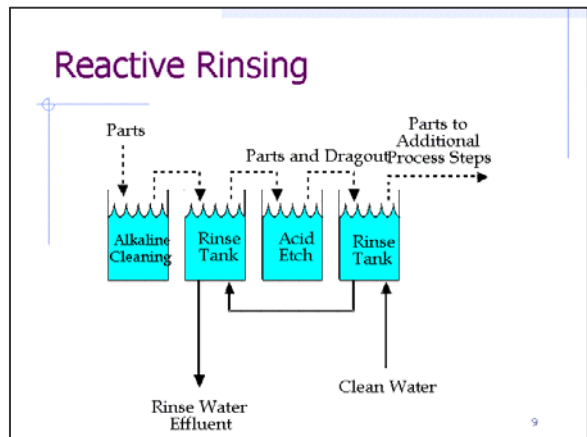

Recycle rinse water – Rinse water constitutes a significant volume of the waste stream generated at metal finishing shops. Rinse water is difficult to treat because it is relatively dilute with respect to contaminants, but high in volume. Therefore, rinse water comprises a significant mass load of contaminants to waste. Pollution prevention philosophy views spent rinse water as a commodity, valuable to the metal finisher. Separating the “contaminants” from the spent rinse water and returning them to the plating baths not only recovers and recycles plating chemicals, it also renders the rinse water once again usable for rinse operations. This unit will present separation technology to enable recycle of rinse water and plating chemicals.

1. Rinse water reduction, extending rinse water life through treatment – reverse osmosis. Reverse osmosis can be effectively used to purify and recycle spent rinse water for reuse in rinse operations. This unit will focus on implementation of reverse osmosis technology.

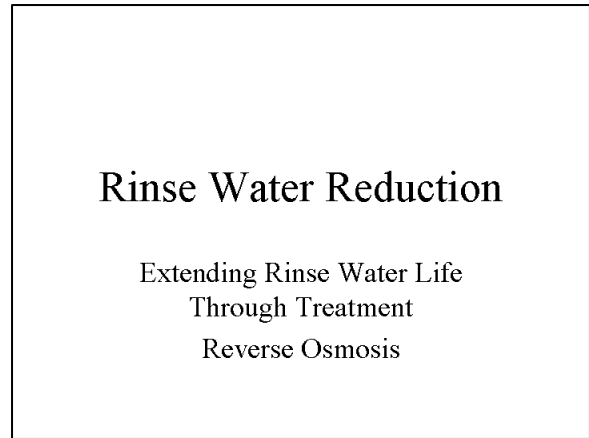

2. Hierarchy of P2 and waste management strategies for metal finishing. This unit will cover methods for recycling rinse water.

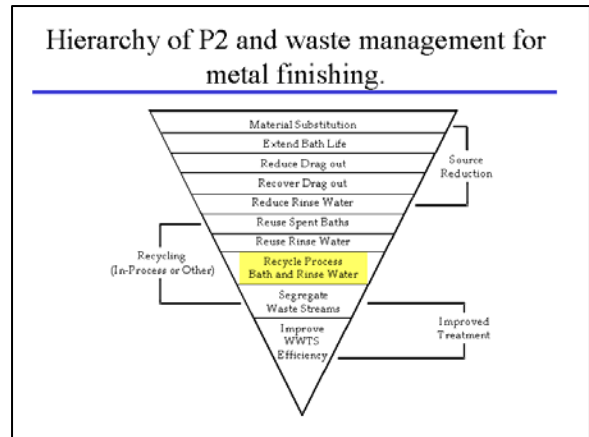

3. Filtration Spectrum. The filtration spectrum is based on categories that have been assigned to selected size ranges for particle removal. Reverse osmosis, the category we are looking at in this unit removes particles in the size range of 0.001 microns and smaller.

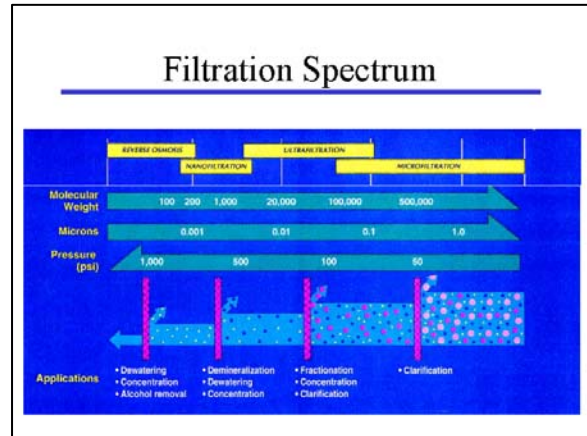

4. Reverse osmosis technology description. This cross sectional view of a tubular shaped RO membrane illustrates the process mechanics. The membrane is contained within a larger diameter tube, which conveys fluid that has permeated the membrane (cleaned fluid). The dirty fluid is fed into the membrane at high pressure. The membrane allows passage of the fluid but rejects particles, retaining them within the membrane tube interior. Permeate is conveyed away for recycling as rinse water; concentrate contains a high concentration of bath chemicals from the bath ahead of the rinse tank in the plating process and can be recycled to that bath for plating chemical make-up.

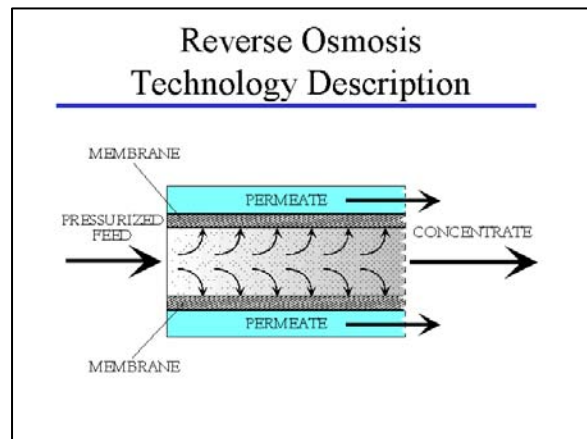

5. Process flow with RO. This schematic illustrates the application of RO for recycling rinse water. Chemicals from the process bath are transferred to the first-stage rinse tank as drag-in. Rinse water, from the first stage rinse tank is withdrawn and filtered to remove large particles prior to RO treatment. Separation of chemical constituents and water occurs in the RO unit, with clean water being routed to the second stage rinse tank and concentrated chemicals being routed back to the process bath. Stage 2 rinse water flows to the stage 1 rinse tank in the counter-current rinse tank configuration, where the process repeats. Make-up water is added to the stage 2 rinse tank, as needed, to maintain water levels.

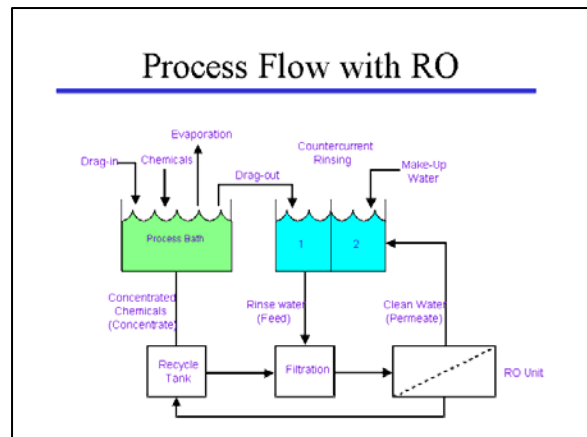

6. RO components. This illustration depicts the RO process components and their configuration.

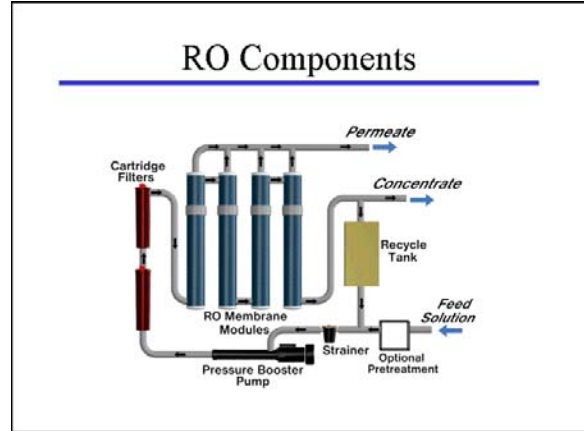

7. RO applications. Reverse osmosis is applicable to many chemical recovery processes, which are listed. RO does not function well with highly concentrated solutions, however, so is more applicable to rinse water recycling in the metal finishing industry.

RO Applications

Most common chemical recovery applications:

- Black dye
- Brass cyanide
- Bright nickel
- Cadmium cyanide
- Copper cyanide
- Nickel acetate seal
- Non-cyanide alkaline zinc
- Watts nickel
- Zinc cyanide

Not applicable to highly concentrated, oxidative solutions, such as chromic and nitric acid

8. RO system case study. A case study was undertaken at a metal plating facility specializing in anodizing. RO processes were utilized for rinse operations for a black dye process and for a nickel-acetate seal process.

RO System Case Study

Facility Description:

- Specializes in:
 - Standard type 2 and hard type 3 anodizing
 - Chemfilm
 - Stainless steel passivation
 - Dye coloring
- Anodize small- to medium-sized parts
 - Commercial and military parts
 - Flashlight parts
 - Bicycle parts

9. Process flow before RO. Prior to implementing the RO process, single stage rinsing was used for both the black dye and nickel acetate seal processes. The rinse tanks required continuous flow feed with fresh water to maintain rinse quality.

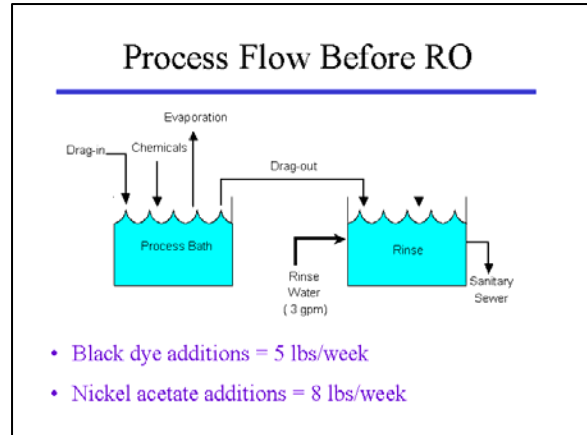

10. Black dye and nickel acetate configuration after RO installation. Two RO units were installed, one for the black dye process and one for the nickel-acetate seal process. Countercurrent rinse tanks were also installed to improve rinse quality and to better utilize the capabilities of the RO process.

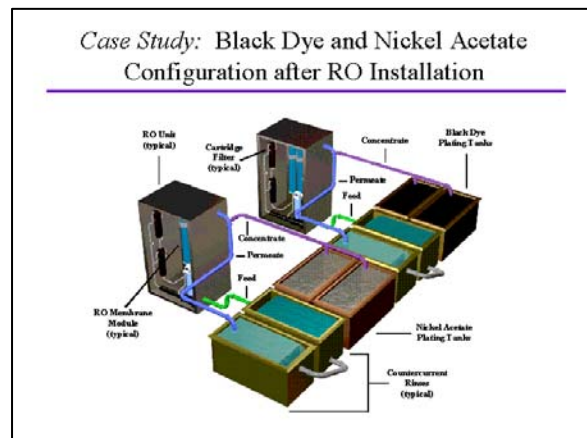

11. RO Units. The RO unit pictured on the left used four modules for the black dye system and the unit pictured on the right used two modules for the nickel acetate system.

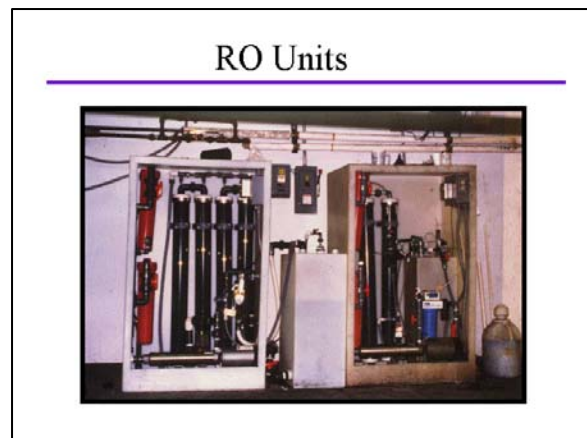

12. RO costs.

RO Costs	
<u>Nickel Acetate System</u>	
Basic System	\$6,200
Upgrades	
UV Light	\$870
Auto-membrane flush system	\$985
Integrated power center	\$565
TOTAL	\$8,620
<u>Black Dye System</u>	
TOTAL	\$10,000

13. Cumulative black dye use. The plot illustrates the reduction in black dye usage from 20.7 lb/mo. prior to the RO system installation to 9.2 lb/mo. after installation. The reduction is attributed to recovery and reuse of dye previously lost to the waste stream in the disposed rinse water.

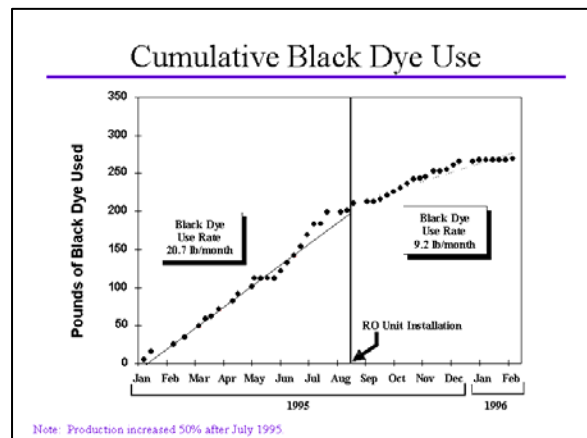

14. RO results for black dye operations. Cost savings are detailed in the table and total savings are compared to capital and O & M costs for the RO system. The payback period is 2.1 years.

RO Results for Black Dye Operations			
	Before	After	Monthly Savings
City Water	3 gpm	0 gpm	\$ 83
POTW Discharge	3 gpm	0 gpm	\$133
Black Dye Chemical	21 lbs/mo	9 lbs/mo	\$293
Total Savings: \$6,100/yr			
O & M Cost: \$1,400/yr			
Capital Cost: \$10,000			
Payback Period: 2.1 years			

15. Video. A case study of another reverse osmosis installation will be presented in the video.

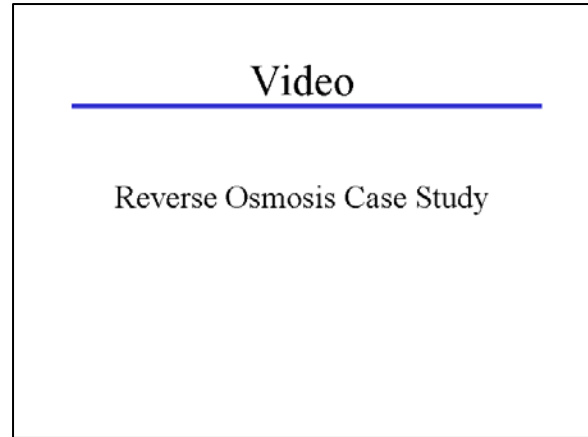

Improving WWTS Efficiency – The traditional response to increasingly stringent discharge requirements has been to invest in improved end of pipe treatment technology. This approach becomes more costly as regulations require lower and lower concentrations of pollutants in effluent discharges. That is precisely the reason that pollution prevention is the preferred alternative and why it is an economically attractive alternative to end of pipe solutions. P2 practices can even be applied to existing end of pipe WWTS to reduce costs and sludge production as the case study at the end of this unit will illustrate.

1. Improving WWTS efficiency – segregating waste streams. The most difficult waste streams to treat are combined wastes. Many contaminants require vastly different treatment practices for removal. By segregating waste streams, appropriate, specific treatment technologies can be applied to more easily remove targeted pollutants. In this unit, the strategy of waste segregation and separate treatment will be presented.

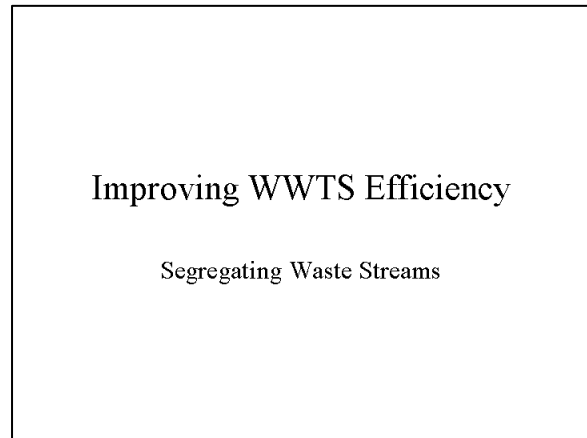

2. Hierarchy of P2 and waste management for metal finishing. The focus of the last pollution prevention unit will be on improved treatment. Both waste stream segregation and improving treatment efficiency will be presented.

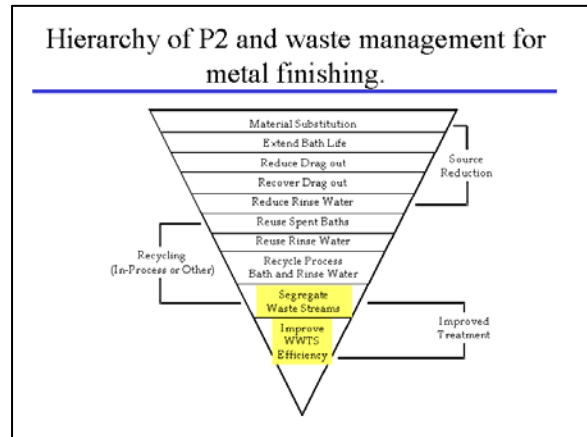

Pollution Prevention Training for Pretreatment Inspectors

3. Facility-wide material flows. This schematic shows a view of the entire metal finishing facility and the relationship of each process to waste generation. Ultimately, all waste streams are routed to the WWTS. By implementing pollution prevention practices on each process in the facility, pollutant loads and flows to the WWTS are reduced. P2 practices effectively segregate waste streams for treatment by treating (and reusing) at the point of pollutant generation.

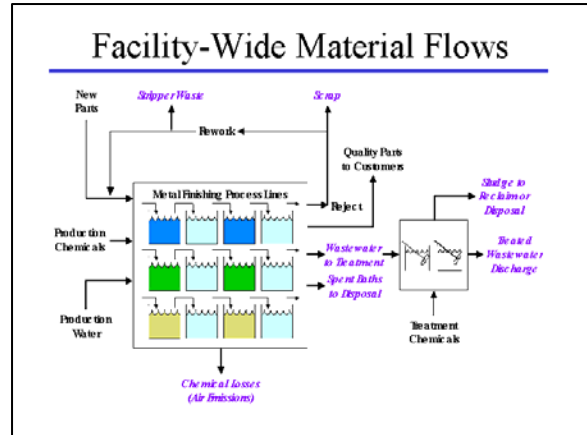

4. P2 as WWTS efficiency improvement strategy. By reducing pollutant mass generated and by concentrating the pollutants that are generated into reduced water volumes, P2 practices help improve WWTS efficiency. Less treatment chemical is required per unit mass of pollutant to treat more concentrated wastes and reduced chemical sludge is produced as a result.

P2 as a WWTS Efficiency Improvement Strategy

- P2 applications have been presented that apply to preparation, plating, and rinsing.
- P2 practices reduce pollutant loads to the WWTS
- P2 practices reduce water volume loads to the WWTS – concentrating pollutants
- Concentrated pollutants are easier to treat and created less chemical sludge

5. Waste stream segregation – By “treating” individual waste streams at their source, P2 practices improve the overall WWTS efficiency by reducing the pollutant loads to the WWTS.

Waste Stream Segregation

- Combined waste streams are more difficult to treat than segregated waste streams.
- P2 practices shift much of the pollution reduction upstream of the WWTS – effectively treating segregated waste streams
- Other segregation, at the WWTS, can reduce pollutants

6. Case study – P2 approach to WWTS. A small anodizing shop was using sodium metabisulfite to reduce toxic chromium (VI) to less harmful chromium (III) in their WWTS. The WWTS contained combined wastes from all processes in the shop and the sodium metabisulfite was dosed for the entire waste stream.

Case Study – P2 Approach to WWTS

- Small anodizing shop
- Acid clean, alkaline etch, anodizing, dying, sealing, chromate conversion, and passivation processes.
- WWTS: batch treatment – chrome reduction, pH adjustment, settling, filter pressing of solids.
- Treatment: 128,000 gallons per month of combined waste.

7. Case study – Sodium metabisulfite reduction in WWTS. A pollution prevention opportunity was identified. Because only one process generated Cr (VI), sodium metabisulfite usage could potentially be reduced by treating the waste from that one process and reducing the Cr (IV) to Cr (III) prior to blending the waste with other waste streams from the facility.

Case Study –Sodium Metabisulfite Reduction in WWTS

- 650 lb of sodium metabisulfite per year used to reduce Cr (VI) to Cr (III) of entire waste stream.
- P2: Add sodium metabisulfite only to the chemfilm rinse waste stream (only source of Cr (VI)).

8. Results – Sodium metabisulfite reduction in WWTS. By segregated the Cr (VI) waste stream and treating it separately, sodium metabisulfite usage was reduced 31%. Resulting cost savings were \$93 per year and there was no cost to implement the change.

Results –Sodium Metabisulfite Reduction in WWTS

- 31% reduction in sodium metabisulfite usage.
- Savings - \$93
- Cost to implement - \$0

Summary

A significant amount of information has been presented over the course of this training. Trying to recall all of the information can seem overwhelming. However, by recalling the hierarchy of P2 and waste management strategies theme, it is easy to organize and remember the approach to pollution prevention presented in the class. Pollution prevention strategies fall into three categories: 1) Source reduction; 2) Recycling; 3) Improved treatment. All of the techniques we've learned fall into those three categories, as illustrated by the hierarchy triangle.

Hierarchy of P2 and waste management for metal finishing.

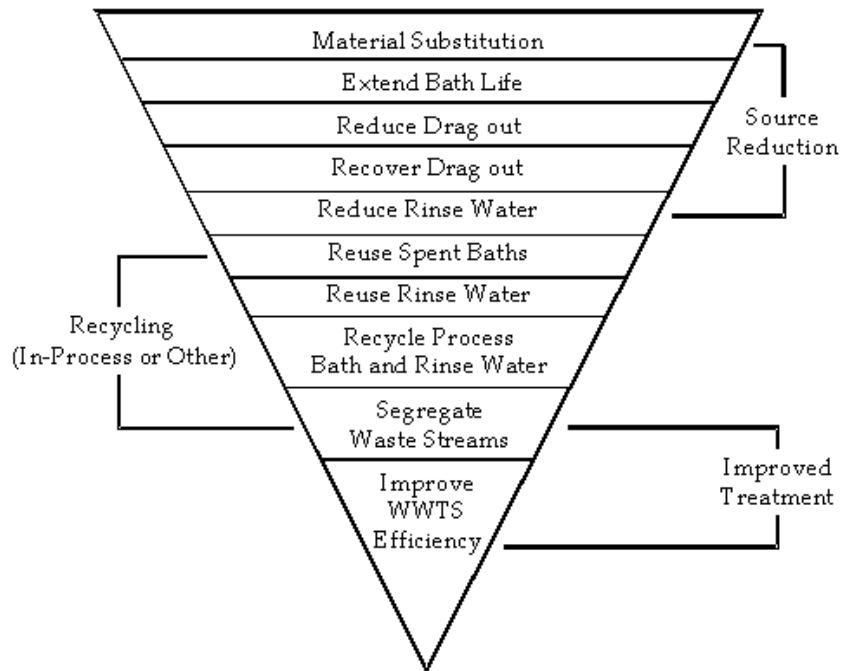

Pollution Prevention Training for Pretreatment Inspectors

Pollution Prevention (P2) Advocacy Discussion – Workshop participants have now been exposed to several pollution prevention practices, have seen examples of those practices successfully implemented at metal finishing facilities, and have seen that the practices both reduce pollutant discharges and reduce operating costs for metal finishing shops.

The purpose for the workshop is to educate pretreatment inspectors about pollution prevention practices from two perspectives. First, the technical perspective is presented, so that inspectors can understand what each practice accomplishes and how it works. Second, the economic perspective is presented, so that inspectors can understand that many P2 practices are economically attractive to business. It is this second perspective that holds the potential for widespread acceptance of a pollution prevention approach to reducing discharges of priority pollutants from metal finishing shops. The goal here is to make inspectors feel comfortable enough about the economic and environmental viability of P2 to advocate it to the metal finishing shops they inspect.

This unit is designed to provide a forum to discuss issues related to the dual role of inspector and P2 advocate. Participants are encouraged to discuss both positive aspects of the dual roles and concerns they may have about the new role. The instructor will introduce two separate exercises to allow the workshop participants to explore and discuss issues regarding advocacy of pollution prevention in the metal finishing industry. Some potential issues are:

1. The inspector will realize the greatest success in interesting metal finishers in pollution prevention by emphasizing the costs facilities incur for hauling off hazardous wastes, providing treatment, and consuming water and how these costs can be reduced by implementing pollution prevention practices.
2. Metal finishers have barriers to implementing pollution prevention practices such as lack of information of P2 benefits, lack of capital, a hesitancy to change existing practices, contract requirements, etc
3. I'm not a "salesman" and don't feel comfortable trying to "sell" the finisher on P2.
4. The inspector's role in P2 advocacy is to help educate finishers and direct them to sources for additional information. The inspector does not have the authority to require implementation of pollution prevention practices.
5. What about liability if I advocate implementation of a practice that doesn't end up working for the metal finisher?
6. Any other topics of interest or concern.

The purpose of the discussion forum is to discuss issues to help overcome barriers. As the previous units illustrated, pollution prevention implementation benefits metal finishers economically by reducing costs and in their environmental regulatory relationships by reducing pollution. The inspector can play an important role in facilitating the realization of those benefits by the finisher.

Pollution Prevention Opportunity Identification Exercise

Facility Profile:

- Medium-size job shop
- Several manual rack plating lines and one manual hoist line
- Business has been good and the facility has seen its water use increase by about 30% in last 6 months
- Facility has history of good compliance with pretreatment requirements; in last few months has experienced a couple metal concentration exceedances
- Facility uses conventional chemical precipitation wastewater treatment

Observations During Facility Visit:

Manual Hoist Line:

- Facility processing large number of angular parts that appear to “cup” solution in certain areas
- Hoist estimated to move vertically at approximately 40 feet per minute
- Line includes standard alkaline pre-clean followed by acid dip prior to plating steps
- All rinses are single stage flowing rinses

Hand Rack Lines:

- Hang bars are present above several of the process tanks
- Static, emersion drag out tanks are used on the decorative chrome line
- All rinse tanks are continuous flow rinses
- Staff appear very busy and parts are processed through the line at a brisk pace

Facility Contact Input:

- The facility contact indicates that the facility has done a lot to reduce water use in the last few years and does not think there is much else that can be done
- Indicates clients are pretty picky on how parts look and that “better, faster, cheaper” is what clients expect from him to keep their business
- Primary concerns for pollution prevention are reduction in stripper waste generated and addressing recent pretreatment system discharge exceedance issues

Exercise Instructions:

- What are some of the P2 techniques that may apply to the facility?
- What are some of the questions you would ask your contact to assess and promote P2 options as you tour the facility and observe the operations?

Pollution Prevention Opportunity Identification Exercise

Potential P2 opportunities for the facility to consider	Questions to ask facility representatives to assess P2 opportunities

Pollution Prevention Advocacy Barriers Exercise

Background: POTW pretreatment program inspectors are being asked to expand their traditional role, focusing on industrial wastewater treatment systems, by also addressing in-process improvements that prevent pollution. The trend appears to be toward adding pollution prevention promotion and assistance to traditional compliance and enforcement.

The purpose of this group discussion is to identify and discuss the various levels of involvement associated with P2 promotion, the barriers to fully integrating P2 promotion into pretreatment inspector duties, and some of the solutions to overcoming these barriers.

Pretreatment inspectors levels of P2 promotion involvement: For the purpose of this group discussion, four levels of P2 Assistance for pretreatment inspectors have been defined:

Level 1 - P2 “Recognition” level - Inspector is aware of P2 opportunities for metal finisher. Inspector asks facility personnel whether they have considered various opportunities. Inspector notes facility response and stops there.

Level 2 - P2 “Promotion” level - In addition to level 1, inspector provides the facility contact with fact sheets, videos and web site resources to help the facility evaluate P2 practices for implementation. Inspectors are knowledgeable of the materials provided and promote the use of the P2 techniques included in the materials.

Level 3 - P2 “Facilitation” level - In addition to Levels 1 and 2, inspector is willing to actively seek out technical assistance/resources for the facility to help them through evaluation and implementation of P2 techniques and technologies (e.g. inspector accesses the web for relevant information, inspector arranges for specialized technical training for one or a group of facilities)

Level 4 - P2 “Technical Assistance” Level – In addition to Levels 1, 2, and 3, inspector is willing to act as a professional consultant to the facility. The inspector helps measure drag out, collect baseline data, and crunch numbers to justify potential P2 opportunities. Inspector helps prepare logs to document results of P2 implementation.

Exercise instructions: Break up into small groups and discuss the following items related to your roles in promoting P2 when visiting your industrial dischargers:

- Starting with Involvement Level 1, discuss the primary barriers to you or your organization promoting P2 during your facility visits. For each primary barrier, list possible solutions, including those within your control and those solutions requiring others, inside or outside of your organization, to address. *Use table on the backside of this sheet to list the group’s ideas.*
- Repeat the exercise for each level and complete the table.
- Discuss, within your group, what level you would personally feel comfortable implementing.
- In discussing barriers and solutions, also consider the following: would the facilities you visit welcome P2 assistance, or will they reject it? What level of assistance would facilities you visit require to effectively implement P2 opportunities?
- After completing the table, reconvene with the entire class and present your groups findings. Discuss with other attendees.

Pollution Prevention Advocacy Barriers Exercise

P2 Promotion Involvement Level	Barriers	Solution to overcome or minimize barrier
Level 1 – Recognize and communicate possible P2 opportunities		
Level 2 – Promote possible P2 opportunities through sharing of technical information and ideas		
Level 3 – Facilitate P2 opportunity evaluation and implementation through seeking assistance for facility.		
Level 4 – Assist in further assessing P2 opportunities and looking into specific P2 options and their costs/benefits.		

Proposed MP&M rule – In late 2000, the U.S. Environmental Protection Agency released the Proposed Metal Products and Machinery (MP&M) Rule. The proposed rule was developed to provide national effluent limitation guidelines and pretreatment standards for wastewater discharges from metal products and machinery facilities. EPA estimates that implementation of the rule, in its present form, will reduce discharge of conventional pollutants by 115 million pounds per year and priority pollutants by 12 million pounds per year. Estimated compliance cost is \$1.98 billion annually. The proposed rule contains many of the pollution prevention methodologies covered in the class today. This fact should help pretreatment inspectors who are advocating implementation of P2 practices to metal finishing shops because the facility managers will have some exposure to P2 concepts and because the proposed regulations will provide added incentive for metal finishers to voluntarily adopt P2 practices.

1. A look into the proposed MP&M rule.
This unit will focus on the provisions of the proposed rule most applicable to metal finishing shops. The full text of the rule is available at www.epa.gov/ost/guide/mpm/.

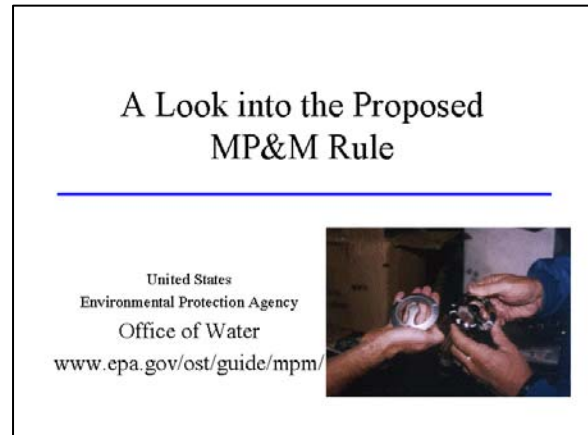

2. MP&M rule proposes. Lower discharge limitations are proposed in the MP&M rule. Pollution prevention alternatives are also included to encourage P2 over end of pipe treatment alternatives.

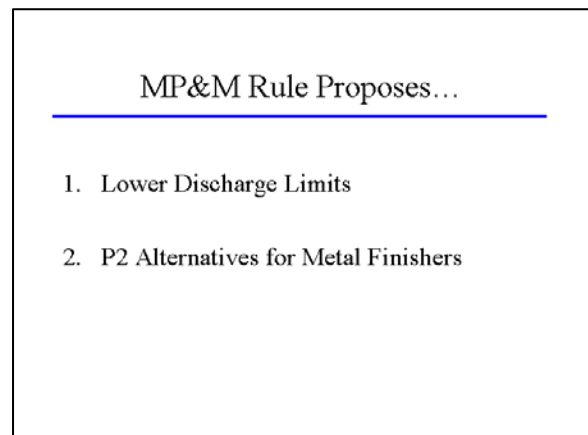

Pollution Prevention Training for Pretreatment Inspectors

3. Pollution prevention alternatives for metal finishing shops (1). The pollution prevention alternatives are organized into ten categories and are summarized here.

Pollution Prevention Alternatives for Metal Finishing Shops

- Category 1: Drag-out reduction and recovery
- Category 2: Good rinse system design for water conservation
- Category 3: Water flow control for water conservation
- Category 4: Process and non-process water segregation
- Category 5: Water conservation practices with air pollution control devices

4. Pollution prevention alternatives for metal finishing shops (2). The pollution prevention alternatives are organized into ten categories and are summarized here.

Pollution Prevention Alternatives for Metal Finishing Shops

- Category 6: Good housekeeping
- Category 7: Minimizing the entry of oil into rinse systems
- Category 8: Dry production sweeping or vacuuming before water rinsing
- Category 9: Drum shipping container rinsate reuse directly in process tanks
- Category 10: Environmental management and record keeping system

5. Category 1 – Drag-out reduction and/or recovery. The remaining slides provide detail for each pollution prevention alternative.

Category 1 Drag-out Reduction and/or Recovery

Drag-out Reduction (≥ 3 on all lines)

- Viscosity and Surface Tension: lower concentration, temperature, or wetting agents
- Drag-out Volume: modifying rack/barrel design and perform rack maintenance to avoid solution trapping under insulation
- Parts Racking: position parts on racks to avoid trapping solution
- Withdrawal Rate: slower rack/barrel withdrawal rates and dwell time
- Barrel rotation to maximize drainage
- Spray/fog rinsing over process tanks
- Drag boards
- Drag-out tanks
- Work with customers to ensure that part design maximizes drainage

Drag-out Reduction (≥ 1 on all lines)

- Evaporators
- Ion Exchange
- Electrowinning
- Electrodialysis
- Reverse Osmosis

OR

Pollution Prevention Training for Pretreatment Inspectors

6. Category 2 – Good rinse design for water conservation. At least three of these practices must be implemented on all lines under this alternative.

Category 2
Good Rinse System Design for Water Conservation
(≥ 3 on all lines)

Tank size: Use the minimum size tank for rinsing and use for the entire plating line, where practical.

Short-circuiting: Locate the water inlet and discharge points at opposite positions in the tank or use a flow distributor.

Air agitation, mechanical mixing

Spray/fog rinses

Multiple counter-flow rinses

Rinse water reuse for successively less critical rinsing

7. Category 3 – Water flow control for water conservation. At least one of these controls is required for all lines under this alternative.

Category 3
Water Flow Control for Water Conservation
(≥ 1 on all lines)

Flow restrictors: Flow restrictors for plating lines with constant production rates; for others, a mechanism or procedure for stopping water flow during idle periods.

Conductivity controls

Timer rinse controls

Production activated control: e.g. spray systems activated when a rack or barrel enters/exits a rinse station.

8. Category 4 – Segregate non-process water from process water / Category 5 – Water conservation practices with air pollution control devices.

Category 4
Segregate Non-Process Water From Process Water

Facilities must not combine non-process water with process wastewater prior to wastewater treatment

Category 5
Water Conservation Practices with Air Pollution Control Devices

Facilities must operate air pollution control devices with wet scrubbers and must recirculate scrubber water as appropriate (periodic blowdown is allowed, as needed).

Where feasible, reuse scrubber water in process baths

Pollution Prevention Training for Pretreatment Inspectors

9. Category 6 – Practice good housekeeping.

Category 6
Practice Good Housekeeping

- **Preventive maintenance** on all valves and fittings (i.e. check for leaks and damage) and repair leaky valves and fittings in a timely manner.
- **Inspect tanks and liners** and repair and replace equipment as necessary to prevent ruptures and leaks. Use tanks and liner materials that are appropriate for associated process solutions.
- **Perform quick cleanup of leaks and spills** in chemical storage and process areas.
- **Remove metal buildup from racks and fixtures**

10. Category 7 – Minimize the entry of oil into rinse systems (At least one of these practices is required under this alternative) / Category 8 – Must sweep or vacuum dry production areas prior to rinsing with water.

Category 7
Minimize the Entry of Oil into Rinse Systems
(≥ 1 of the following)

Use oil skimmers or other oil removal devices in cleaning baths.

Work with customers to degrease parts prior to shipment to minimize the amount of oils on incoming materials

Category 8
Must Sweep or Vacuum Dry Production Areas Prior to Rinsing with Water

Sweep or vacuum dry production area floors prior to water rinsing

11. Category 9 – Reuse drum/shipping container rinsate directly in process tanks.

Category 9
Reuse Drum/Shipping Container Rinsate Directly in Process Tanks

Reuse rinsate from raw material drums, storage drums, and/or shipping containers that contain pollutants regulated under the MP&M regulation directly into process tanks or save for use in future production.

Pollution Prevention Training for Pretreatment Inspectors

12. Category 10 – Environmental management and record keeping system.

Category 10
Environmental Management and Record Keeping System

Implement an environmental management program that includes, but is not limited to, the following elements:

- Pollution prevention policy statement
- Environmental performance goals
- Pollution prevention assessment
- Pollution prevention plan
- Environmental tracking and record keeping system
- Procedures to optimize control parameter settings (e.g. ORP set point in cyanide destruction systems, optimum pH for chemical precipitation systems, etc.)
- Statement delineating minimum training levels for wastewater treatment operators.

Pollution Prevention Training for Pretreatment Inspectors

Site visit – Today the class will be visiting a metal finishing facility to see, first hand, pollution prevention practices that have been successfully implemented and to explore opportunities for other P2 practices. The visit will be conducted by a management representative from the host facility and by your instructor. While visiting the facility, students will also participate in a “hands-on” exercise designed to demonstrate the benefits of utilizing a pollution prevention practice. There will be a debriefing after the facility tour to discuss what was observed and to evaluate the results from the “hands-on” exercise. Facility management will discuss their experiences with implementing pollution prevention practices, including start-up, shakedown, employee acceptance and buy-in, and evaluation techniques. Students are encouraged to ask questions and discuss issues with facility managers and the instructor during the tour and at the debriefing.

There are several goals for this part of the training:

1. Provide the opportunity for students to see P2 practices that have been implemented by a metal finishing facility.
2. Discuss issues associated with P2 implementation.
3. Practice looking for P2 opportunities and advocating for their implementation.
4. Gain first-hand experience implementing a P2 practice and measure results.
5. Discuss the compatibility of the inspector’s roles as enforcer and as advocate for change.

The instructor will facilitate the debriefing and discussion and the metal finishing facility representative will be present to provide an industry perspective. Students are encouraged to use this opportunity to speak openly and to discuss issues related to P2 implementation and the inspector’s role in educating industry about its benefits and advocating for its implementation.

Safety

Prior to visiting the metal finishing facility, the instructor will discuss safety issues relevant to your visit. Students must wear closed-toe shoes and safety glasses. It is important to keep in mind that baths and rinses can have elevated temperatures, very high or very low pH, and

can have electrical current flowing through them. Keep in mind that the facility is an industrial environment with many potential hazards. Listen to your instructor and management host and exercise caution while visiting the facility.

Unit 14

Facility Visit to Discuss P2 Techniques

Metal Finishing Facility Visit

- Objective:
 - Gain familiarity with metal finishing processes
 - Understand metal finisher's perspective on P2 techniques and technologies
- Site Visit Activities:
 - Overview of facility operations;
 - Guided walk-through focused on processes lines
 - Discussions with facility staff on P2 opportunities
- Post Visit Discussion:
 - What were the various metal finishing processes?
 - What P2 opportunities did you see?
 - How would you approach promoting the P2 opportunities?
 - How can integrate P2 into your role as pretreatment inspectors?

Pre-visit Facility Overview

- Products and Processes
- Facility P2 accomplishments and Interests
- Sample checklists



Companies Typically Utilize 3 Sources of Information

- Customers
- Competition
- Accountants

A P2 Opportunity will usually be considered if...

1. The opportunity is technically qualified
2. The opportunity is consistent with business realities



Metal Finishers Often Believe They Need to Balance P2 against:

- Throughput
- Reject Rate
- Downtime
- Operating Costs
- Environmental Compliance

Pollution Prevention Training for Pretreatment Inspectors

Post-Visit Discussion of Facility Observations

- Processes
- P2 Opportunities
- Strategies for promoting opportunities
- Role of Pretreatment Inspectors

Involvement of Pretreatment Inspectors in P2 Promotion

- Be aware of P2 concepts and Techniques
- Take time on-site to understand operations and develop P2 opportunities
- Be armed with P2 technical assistance information
- Encourage source reduction when discussing pretreatment issues

Drivers for POTW P2 Involvement

- SB 709 Law
 - POTW authority to require development of P2 plans and implementation of P2 opportunities
- MP&M Proposed Rule
 - Alternative P2 track requires knowledge of P2 techniques and their application
- Others - Local ordinances, permit requirements?

Pollution Prevention for Metal Finishing - Inspection Checklist

This checklist addresses common pollution prevention (P2) opportunities at metal finishing facilities, but is not exhaustive. The main purpose of the checklist is to assess the extent to which these opportunities have been implemented at a facility (the more “yes” answers, the more P2). The completed checklist can be used to stimulate discussion and inquiry by facility personnel.

QUESTION	YES	NO	NA	UNKNOWN
Management				
Does the company have an environmental policy?	<input type="checkbox"/>	<input type="checkbox"/>	<input type="checkbox"/>	<input type="checkbox"/>
Does the policy specifically address <i>pollution prevention</i> ?	<input type="checkbox"/>	<input type="checkbox"/>	<input type="checkbox"/>	<input type="checkbox"/>
Does the facility routinely track and chart:				
• Reject/rework	<input type="checkbox"/>	<input type="checkbox"/>	<input type="checkbox"/>	<input type="checkbox"/>
• Water use	<input type="checkbox"/>	<input type="checkbox"/>	<input type="checkbox"/>	<input type="checkbox"/>
• Process chemical use	<input type="checkbox"/>	<input type="checkbox"/>	<input type="checkbox"/>	<input type="checkbox"/>
• Wastewater treatment chemical use	<input type="checkbox"/>	<input type="checkbox"/>	<input type="checkbox"/>	<input type="checkbox"/>
• Electricity and gas use	<input type="checkbox"/>	<input type="checkbox"/>	<input type="checkbox"/>	<input type="checkbox"/>
• Others (list):	<input type="checkbox"/>	<input type="checkbox"/>	<input type="checkbox"/>	<input type="checkbox"/>
Are any of the data normalized by production metrics?				
What less hazardous/toxic chemical alternatives have been adopted in the last 5 years?				
• Water-based degreasing (specify: _____)	<input type="checkbox"/>	<input type="checkbox"/>	<input type="checkbox"/>	<input type="checkbox"/>
• Non-cyanide zinc plating	<input type="checkbox"/>	<input type="checkbox"/>	<input type="checkbox"/>	<input type="checkbox"/>
• Non-cyanide strippers (specify: _____)	<input type="checkbox"/>	<input type="checkbox"/>	<input type="checkbox"/>	<input type="checkbox"/>
• Others (list):	<input type="checkbox"/>	<input type="checkbox"/>	<input type="checkbox"/>	<input type="checkbox"/>
Bath Maintenance				
Is there a rack maintenance program to prevent metal buildup on racks?	<input type="checkbox"/>	<input type="checkbox"/>	<input type="checkbox"/>	<input type="checkbox"/>
Are tools for removing parts dropped into process baths readily available and are they used regularly, as needed?	<input type="checkbox"/>	<input type="checkbox"/>	<input type="checkbox"/>	<input type="checkbox"/>
Is deionized (DI) or reverse osmosis (RO) water used for process bath makeup?				
Are process baths analyzed in an on-site laboratory?	<input type="checkbox"/>	<input type="checkbox"/>	<input type="checkbox"/>	<input type="checkbox"/>
Are chemical additions made by dedicated, trained staff?	<input type="checkbox"/>	<input type="checkbox"/>	<input type="checkbox"/>	<input type="checkbox"/>
Are chemical additions recorded and charted using statistical process control (SPC) methods?	<input type="checkbox"/>	<input type="checkbox"/>	<input type="checkbox"/>	<input type="checkbox"/>
What methods are practiced to reduce bath dump frequency? Describe:				

Pollution Prevention Training for Pretreatment Inspectors

QUESTION	YES	NO	NA	UNKNOWN
Drag-out				
Are drag-out rates ever measured from a plating bath?	<input type="checkbox"/>	<input type="checkbox"/>	<input type="checkbox"/>	<input type="checkbox"/>
Do supervisors/upper management review how parts are positioned on racks to minimize dragout?	<input type="checkbox"/>	<input type="checkbox"/>	<input type="checkbox"/>	<input type="checkbox"/>
Are drip boards in place to cover gaps between process tanks?	<input type="checkbox"/>	<input type="checkbox"/>	<input type="checkbox"/>	<input type="checkbox"/>
Are workers periodically reminded through formal training about best practices for dragout reduction?	<input type="checkbox"/>	<input type="checkbox"/>	<input type="checkbox"/>	<input type="checkbox"/>
After parts are withdrawn from a process tank, do workers use reasonable (2 to 5 seconds) hang time?	<input type="checkbox"/>	<input type="checkbox"/>	<input type="checkbox"/>	<input type="checkbox"/>
Rinsing				
Are automated spray systems used to rinse parts over heated process baths? How many:	<input type="checkbox"/>	<input type="checkbox"/>	<input type="checkbox"/>	<input type="checkbox"/>
Are hand-held spray guns used to rinse parts over heated process baths? How many:	<input type="checkbox"/>	<input type="checkbox"/>	<input type="checkbox"/>	<input type="checkbox"/>
Are spray systems used after process baths for rinsing in a manner that facilitated rinse water reuse? How many:	<input type="checkbox"/>	<input type="checkbox"/>	<input type="checkbox"/>	<input type="checkbox"/>
Are rinses systems operated properly (good mixing, flow control, not short circuiting, reasonable freeboard)?	<input type="checkbox"/>	<input type="checkbox"/>	<input type="checkbox"/>	<input type="checkbox"/>
Are flow restrictors used on rinse tanks? How many:	<input type="checkbox"/>	<input type="checkbox"/>	<input type="checkbox"/>	<input type="checkbox"/>
Are conductivity control systems used to regulate rinse water flow? How many:	<input type="checkbox"/>	<input type="checkbox"/>	<input type="checkbox"/>	<input type="checkbox"/>
Are timers used to turn rinse water flow off?	<input type="checkbox"/>	<input type="checkbox"/>	<input type="checkbox"/>	<input type="checkbox"/>
What percentage of plating tanks is followed by a static dragout tank?	_____ %			
What percentage of rinse tanks is counterflow?	_____ %			
Recycling/Recovery				
Are evaporator systems used to recover process chemicals for reuse? Describe:				
Are ion exchange systems used to recover process chemicals and/or water for reuse? Describe:				
Are any technologies used to “close loop” rinse water use? Describe:				

Pollution Prevention Training for Pretreatment Inspectors

Helpful Reference Material

The following list provides access to reference materials for further information of pollution prevention in metal finishing. Many of the listed websites provide links to other useful websites.

U.S. EPA	http://es.epa.gov/techinfo/facts/facts.html
U.S. EPA Region 9	http://www.epa.gov/region09/cross_pr/merit/metal.html
Office of Water Programs, California State University, Sacramento	http://www.owp.csus.edu
Pacific Northwest Pollution Prevention Resource Center	http://www.pprc.org/pprc/sbap/metalfin.html
Northeast Waste Management Officials' Association	http://www.glrppr.uiuc.edu/packets/finishing/toc1.htm
American Electroplaters and Surface Finishers Association	http://www.aesf.org
National Association of Metal Finishers	http://www.namf.org
California Water Environment Association Industrial and Hazardous Waste Committee	http://www.cwea.org/iHW